

# A TECHNICAL OVERVIEW OF IEEE 802.16M TECHNOLOGY

Document Number: IEEE C802.16-10/002  
Date Submitted: 2010-01-11  
Source:

Sassan Ahmadi (Intel Corporation) [sassan.ahmadi@intel.com](mailto:sassan.ahmadi@intel.com)

Jeongho Park, Taeyoung Kim, Jaeweon Cho, Hokyuu Choi (Samsung Electronics), Wookbong Lee, Jin Sam Kwak (LG Electronics)

I-Kang Fu, Kelvin Chou, Yu-Hao Chang, Pei-Kai Liao, Chih-Yuan Lin, Yih-Shen Chen, Paul Cheng (MediaTek Inc.)

Mitsuo Nohara, Satoshi Imata (KDDI R&D Laboratories), Kenji Saito (UQ Communications)

Zheng Yan-Xiu, Yu-Tao Hsieh (ITRI),

Venue: IEEE Session #65 San Diego, CA USA

Base Contribution: None

Purpose: A technical overview of IEEE 802.16m technology for IEEE 802.16 IMT-Advanced Evaluation Group Coordination Meeting

## Notice:

*This document does not represent the agreed views of the IEEE 802.16 Working Group or any of its subgroups. It represents only the views of the participants listed in the "Source(s)" field above. It is offered as a basis for discussion. It is not binding on the contributor(s), who reserve(s) the right to add, amend or withdraw material contained herein.*

## Release:

The contributor grants a free, irrevocable license to the IEEE to incorporate material contained in this contribution, and any modifications thereof, in the creation of an IEEE Standards publication; to copyright in the IEEE's name any IEEE Standards publication even though it may include portions of this contribution; and at the IEEE's sole discretion to permit others to reproduce in whole or in part the resulting IEEE Standards publication. The contributor also acknowledges and accepts that this contribution may be made public by IEEE 802.16.

## Patent Policy:

The contributor is familiar with the IEEE-SA Patent Policy and Procedures:

<<http://standards.ieee.org/guides/bylaws/sect6-7.html#6>> and

<<http://standards.ieee.org/guides/opman/sect6.html#6.3>>.

Further information is located at <<http://standards.ieee.org/board/pat/pat-material.html>> and <<http://standards.ieee.org/board/pat>>.

# Outline

- General Description and Features
- IEEE 802.16m Physical Layer
  - Frame Structure
  - DL/UL Subchannelization and Permutation
  - HARQ Protocols and Timing
  - Downlink/Uplink MIMO Schemes
  - Modulation and Coding
  - Downlink Synchronization and Control Channels
  - Uplink Control Channels
- IEEE 802.16m Medium Access Control
  - MAC Addressing
  - Network Entry
  - Connection Management
  - Quality of Service
  - MAC Management Messages
  - MAC Headers
  - ARQ and HARQ Functions
  - Mobility Management and Handover
  - Power Management
  - Security
- Support of Legacy Systems
- Advanced Features
- References

## **General Description and Features**

# Advanced Features in IEEE 802.16m

- IEEE 802.16m incorporates some advanced functions relative to the legacy system including:
  - New subframe-based frame structure that allows faster air-link transmissions/retransmissions, resulting in significantly shorter user-plane and control plane latencies.
- New subchannelization schemes and more efficient pilot structures in the downlink and uplink to reduce L1 overhead and to increase spectral efficiency.
  - New and improved control channel structures in the downlink and uplink to increase efficiency and reduce latency of resource allocation and transmission as well as system entry/re-entry.
- Multi-carrier operation using a single MAC instantiation to enable operation in contiguous/non-contiguous RF bands in excess of 20 MHz
- Extended and improved MIMO modes in the downlink and uplink
- Enhanced Multicast and Broadcast Services using new E-MBS control channels and subchannelization
- Enhanced GPS-based and Non-GPS-based Location Based Services
- Support of Femto Cells and Self-Organization and Optimization features
- Increased VoIP capacity through use of new control structure, frame structure, faster HARQ retransmissions, persistent scheduling, group scheduling, and reduced MAC overhead.

# Advanced Features in IEEE 802.16m

- Improved and increased control channel and data channel coverage and link budget through use of transmit diversity schemes as well as more robust transmission formats and link adaptation.
- Support for multi-hop relay operation with unified access and relay links
- Support for advanced interference mitigation techniques including Multi-BS MIMO, Fractional Frequency Reuse, Closed-loop and Open-loop power control schemes.
- Improved intra-RAT and inter-RAT handover schemes with shorter handoff interruption times
- Improved sleep and idle mode operations
- Improved QoS support

# IEEE 802.16m Reference Model

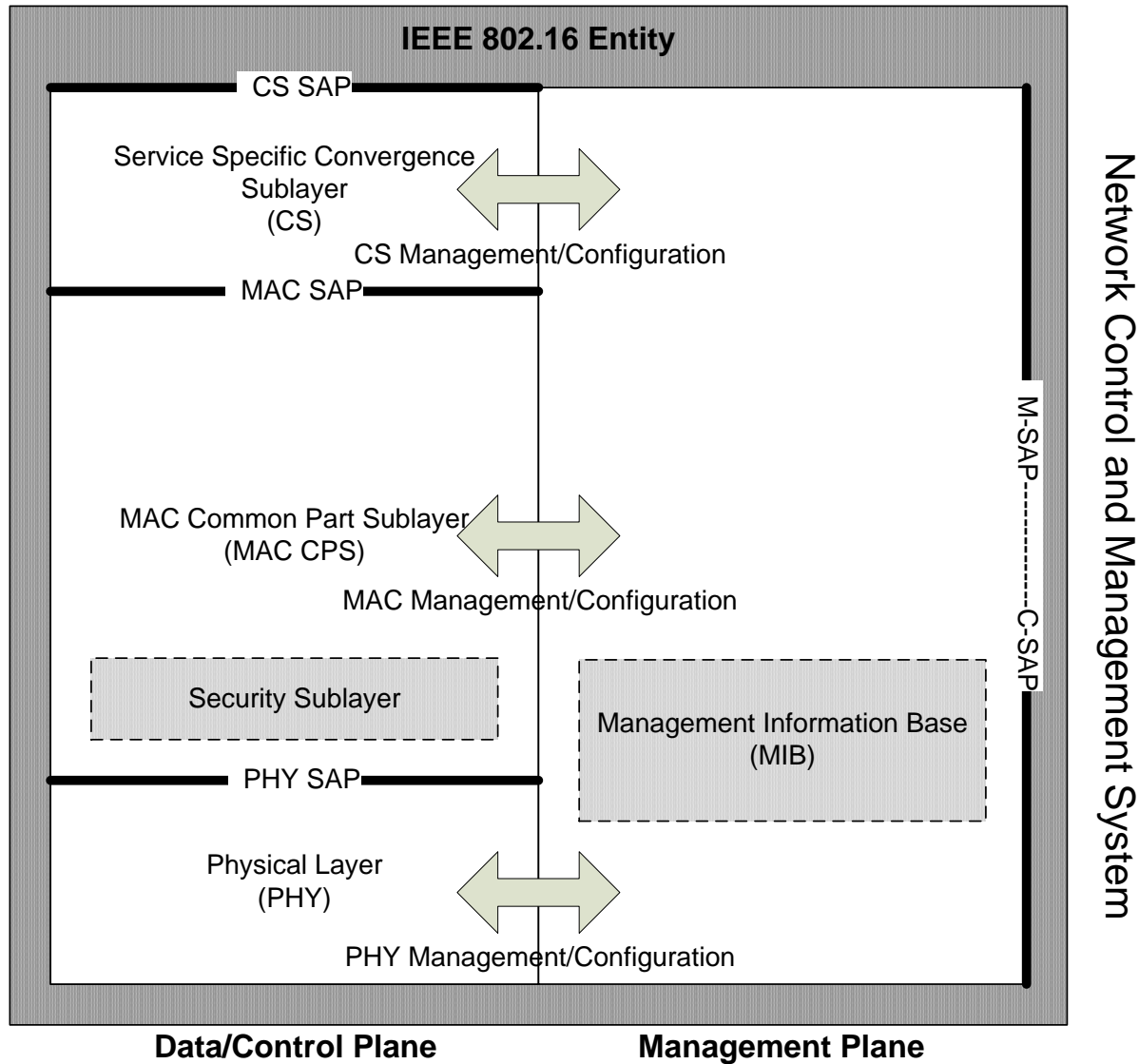

# IEEE 802.16m Protocol Structure

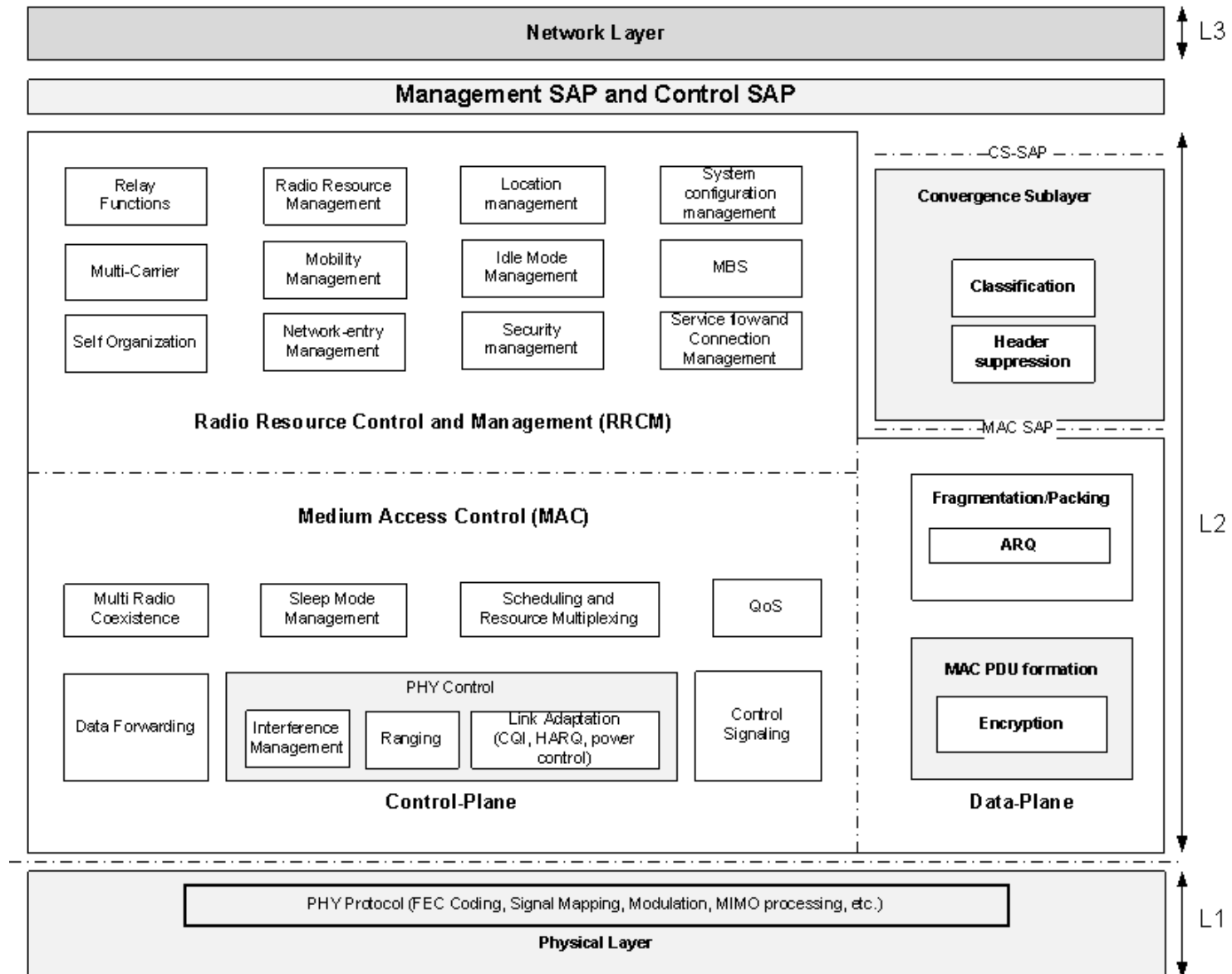

# Frame Structure

# IEEE 802.16m OFDMA Numerology

Nominal channel bandwidth (MHz)		5	7	8.75	10	20	
Sampling factor		28/25	8/7	8/7	28/25	28/25	
Sampling frequency (MHz)		5.6	8	10	11.2	22.4	
FFT size		512	1024	1024	1024	2048	
Sub-carrier spacing (kHz)		10.94	7.81	9.76	10.94	10.94	
Useful symbol time $T_u$ ( $\mu$ s)		91.429	128	102.4	91.429	91.429	
CP $T_g=1/8 T_u$	Symbol time $T_s$ ( $\mu$ s)		102.857	144	115.2	102.857	102.857
	FDD	Number of OFDM symbols per 5ms frame	48	34	43	48	48
		Idle time ( $\mu$ s)	62.857	104	46.40	62.857	62.857
	TDD	Number of OFDM symbols per 5ms frame	47	33	42	47	47
TTG + RTG ( $\mu$ s)		165.714	248	161.6	165.714	165.714	
CP $T_g=1/16 T_u$	Symbol time $T_s$ ( $\mu$ s)		97.143	136	108.8	97.143	97.143
	FDD	Number of OFDM symbols per 5ms frame	51	36	45	51	51
		Idle time ( $\mu$ s)	45.71	104	104	45.71	45.71
	TDD	Number of OFDM symbols per 5ms frame	50	35	44	50	50
TTG + RTG ( $\mu$ s)		142.853	240	212.8	142.853	142.853	
CP $T_g=1/4 T_u$	Symbol Time $T_s$ ( $\mu$ s)		114.286	160	128	114.286	114.286
	FDD	Number of OFDM symbols per 5ms frame	43	31	39	43	43
		Idle time ( $\mu$ s)	85.694	40	8	85.694	85.694
	TDD	Number of OFDM symbols per 5ms frame	42	30	37	42	42
TTG + RTG ( $\mu$ s)		199.98	200	264	199.98	199.98	

IEEE 802.16m uses OFDMA in both uplink and downlink as the multiple access scheme

IEEE 802.16m supports other bandwidths between 5MHz and 20MHz than listed by dropping edge tones from 10MHz or 20MHz

# Basic Frame Structure (FDD/TDD)

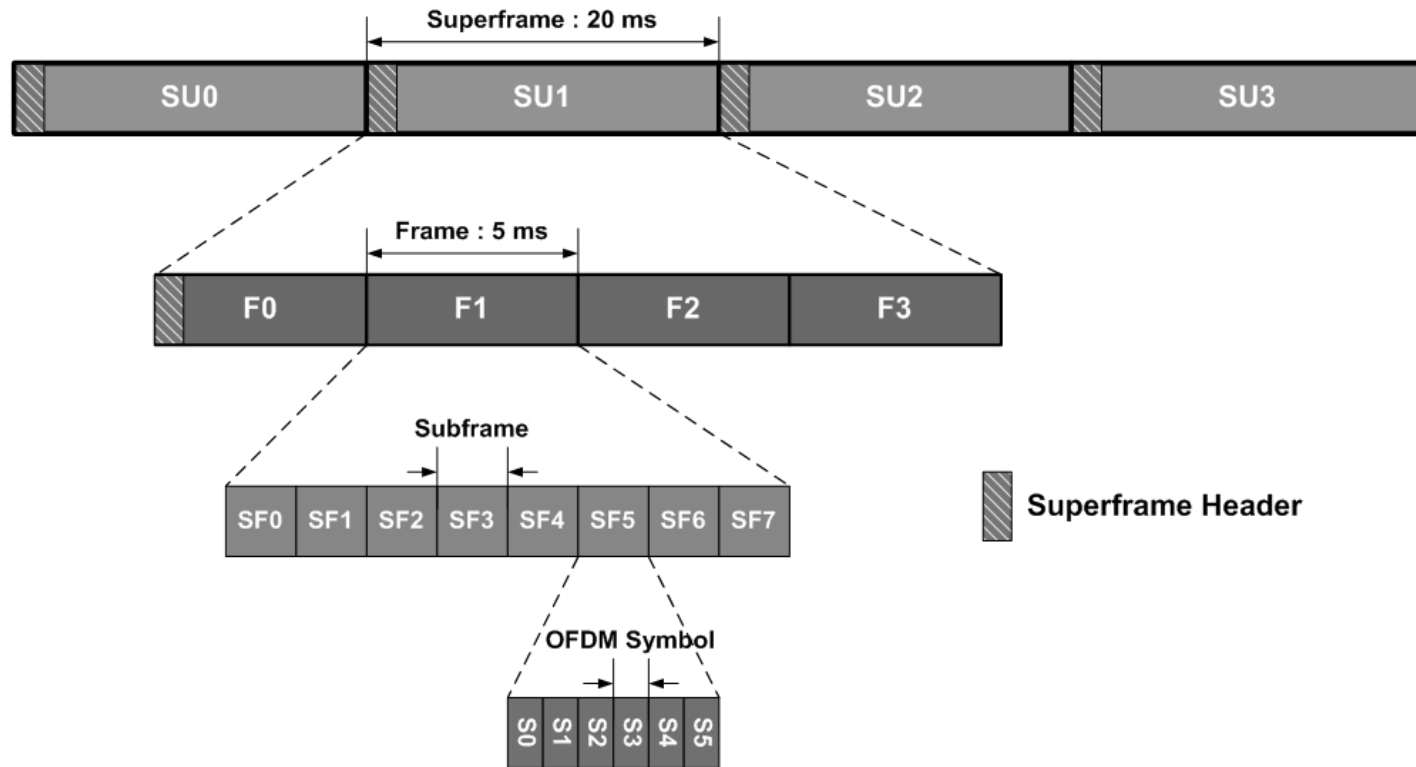

Superframe (20ms) comprises 4 radio frames

Radio frame (5 ms) consists of 8,7,6, or 5 subframes (depending on frame configuration)

DL/UL subframes contain 6,5,7,or 9 OFDM symbols

# CP=1/8 Basic Frame Structure (DL/UL=5:3)

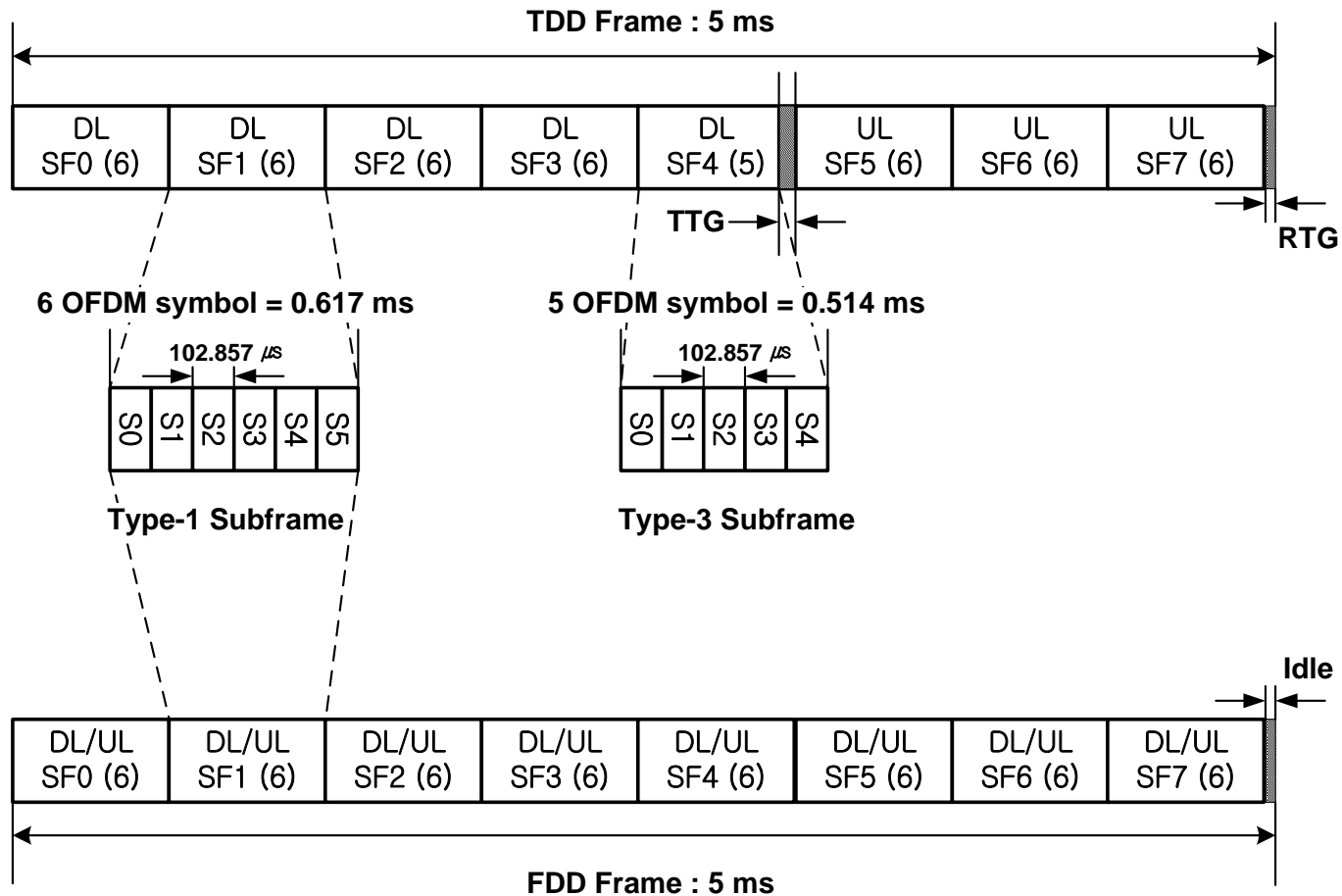

Supported DL/UL ratio in unit of subframes: 3:5, 4:4, 5:3, 6:2, 8:0

# CP=1/16 Frame Structure (DL/UL=5:3)

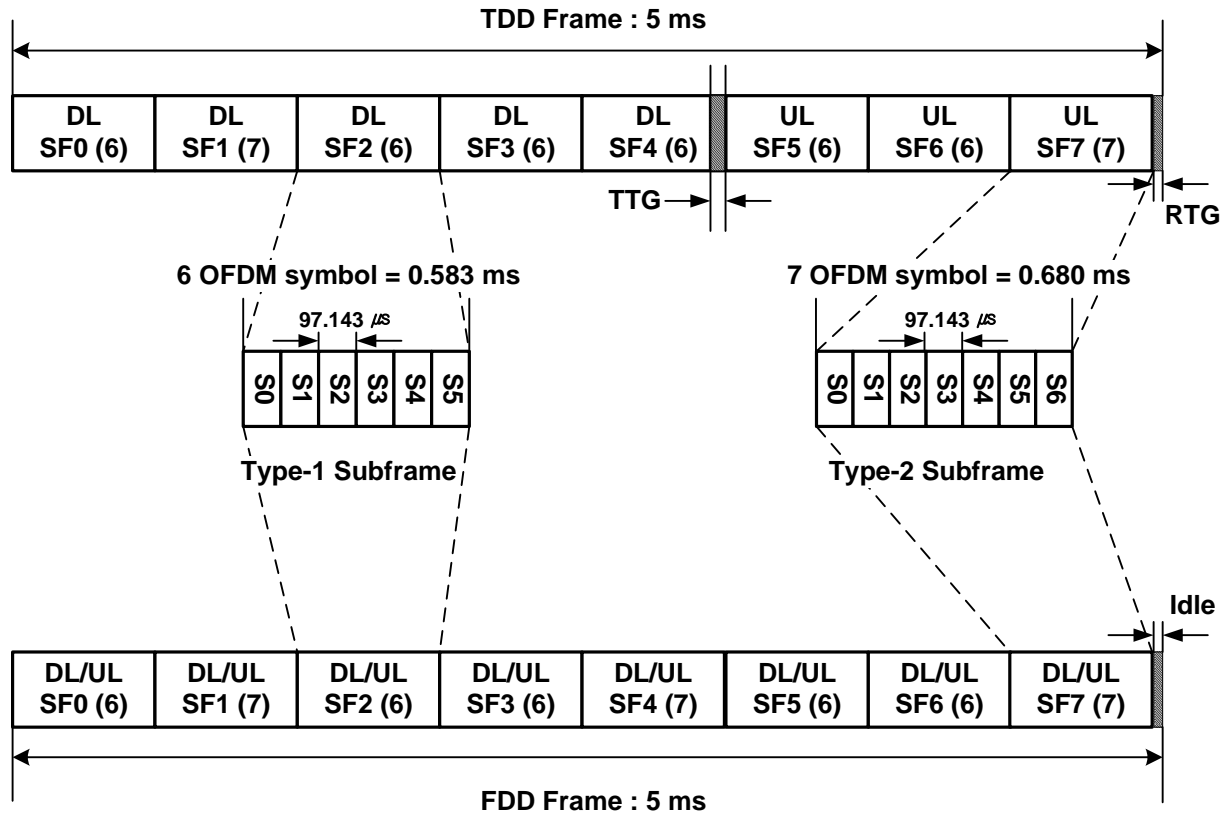

# **DL/UL Subchannelization and Permutation**

# DL/UL Subchannelization and Permutation

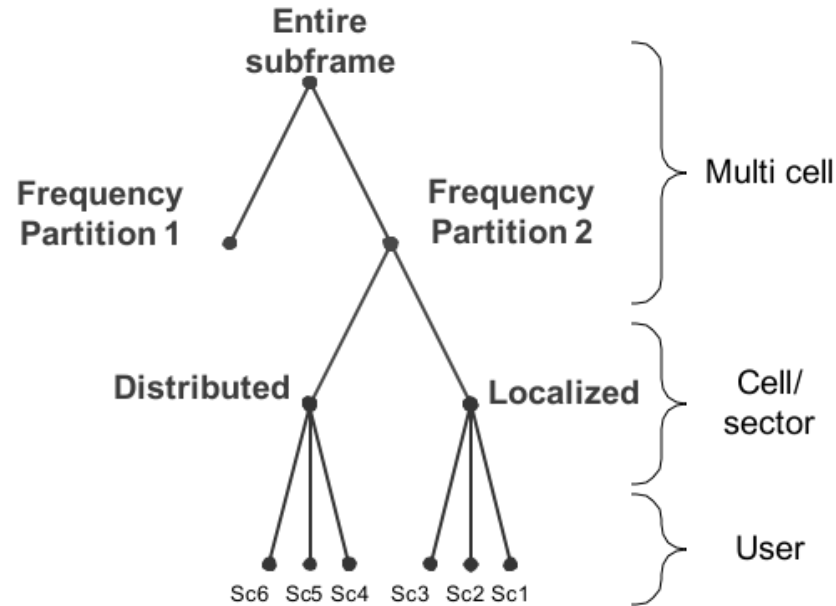

**Physical Resource Unit (PRU)** is the basic physical unit for resource allocation that comprises  $P_{sc}$  consecutive subcarriers by  $N_{sym}$  consecutive OFDMA symbols.  $P_{sc}$  is 18 subcarriers and  $N_{sym}$  is 6, 7, and 5 OFDMA symbols.

**Logical Resource Unit (LRU)** is the basic logical unit for localized and distributed resource allocations.

**Distributed Resource Unit (DRU)** achieves frequency diversity gain by grouping of subcarriers which are spread across the distributed resources within a frequency partition.

**Localized Resource Unit or Contiguous Resource Unit (CRU)** achieves frequency-selective scheduling gain by grouping subcarriers which are contiguous across the localized resource allocations within a frequency partition.

# DL/UL Subchannelization and Permutation

- Concurrent distributed and localized transmissions in the subframe
  - UL/DL DRU: tiles/tone-pair permutation ( similar to UL/DL PUSC in the legacy standard)
  - Sub-band CRU: localized resource with band selection (similar to band AMC in the legacy standard)
  - Mini-band CRU: diversity resource with dedicated pilots
- Concurrent frequency reuse-1 and FFR
  - Up to 4 frequency partitions: one reuse-1 and three reuse-3
  - Low power transmission is allowed on other segments' reuse-3 frequency partitions
- UL is similar to DL structure except
  - UL DRU use tile similar to PUSC tile (instead of subcarrier)
  - Legacy support with IEEE 802.16m PUSC mode (4x6 tile)

# DL/UL Subchannelization and Permutation

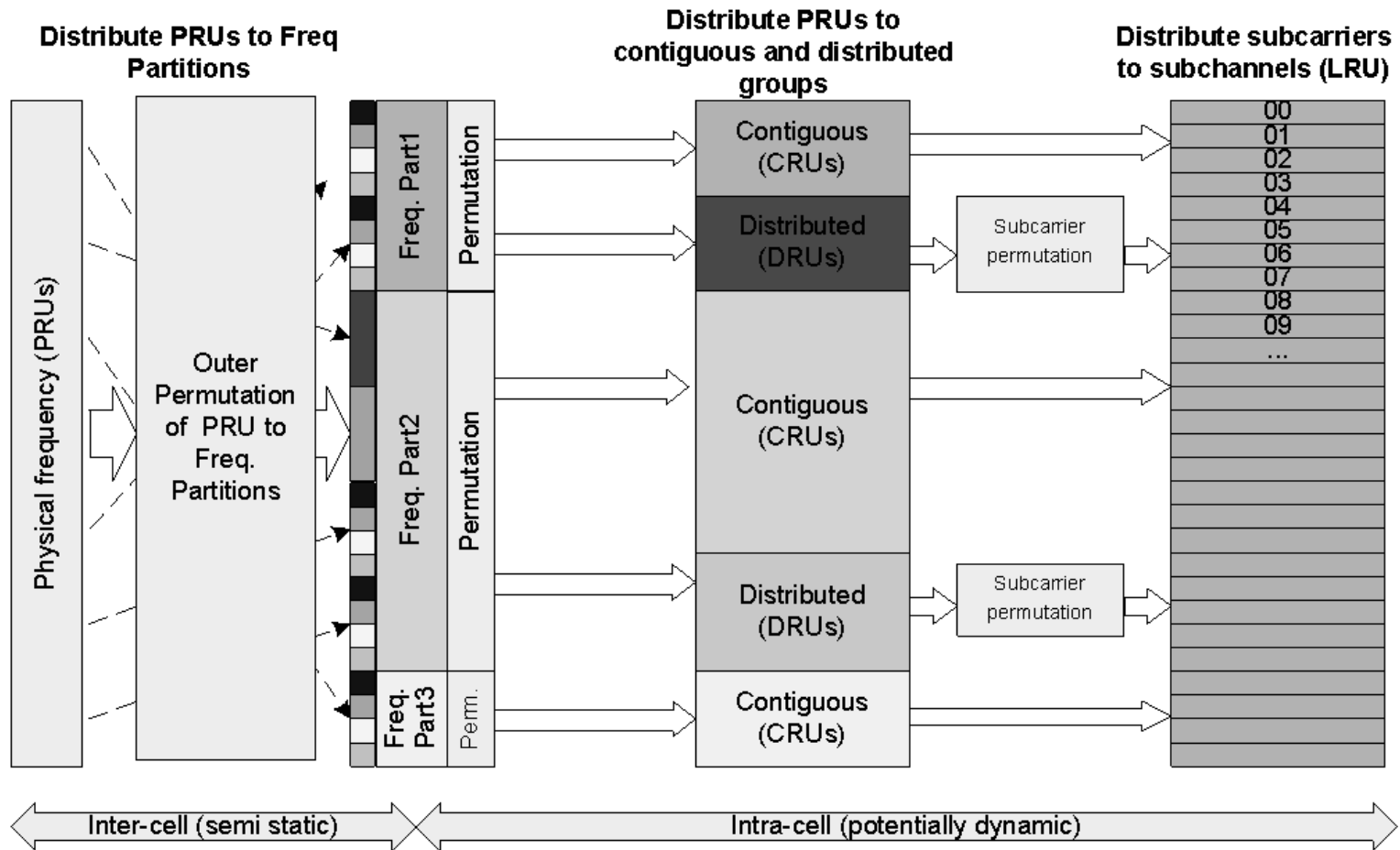



# DL/UL Pilot Patterns

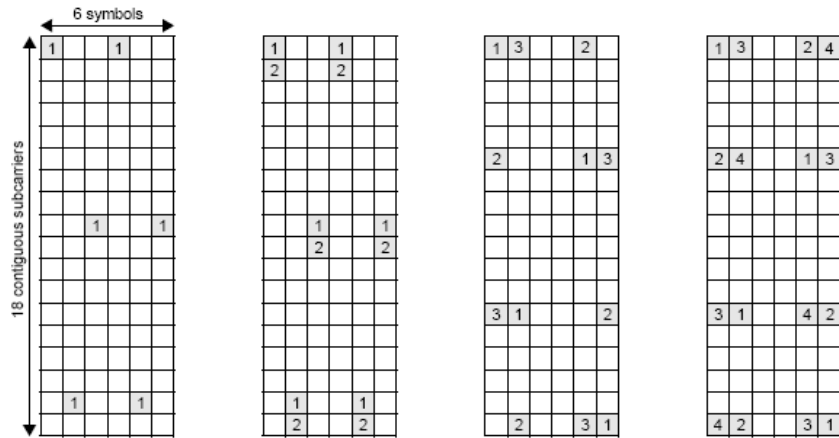

DL Pilot Structure for 1, 2, 3, and 4 Stream

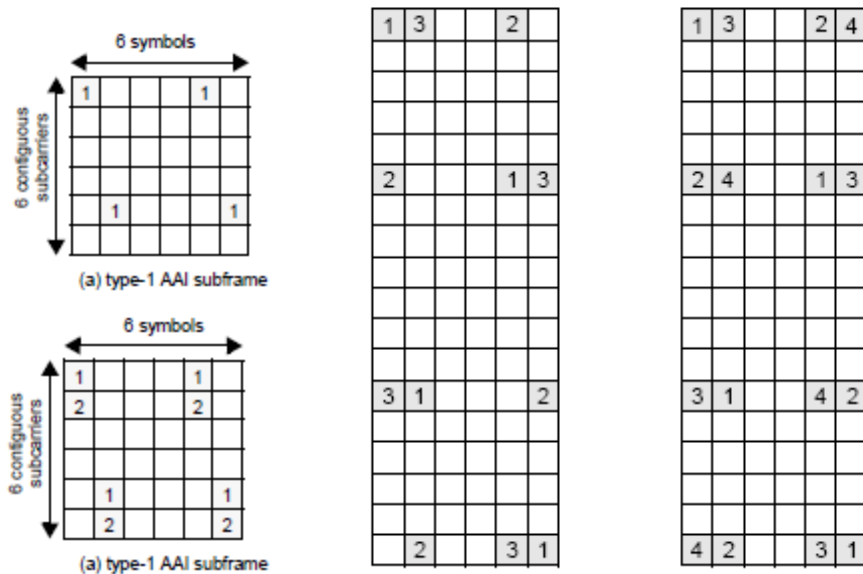

UL Pilot Structure for 1, 2, 3, and 4 Stream

- Up to 8 streams in the DL and up to 4 streams in the UL
- Dedicated precoded pilots are used
- Shared pilots for DL DRU, always two streams
- Pilots density is adapted to number of streams
  - 5.6% pilot overhead per stream for DL 1 or 2 streams
  - 3.7% per stream for 3 or 4 streams
- Interlaced pilots (pilots collides with data) are used to exploit pilot boosting gain

# DL/UL Pilot Patterns

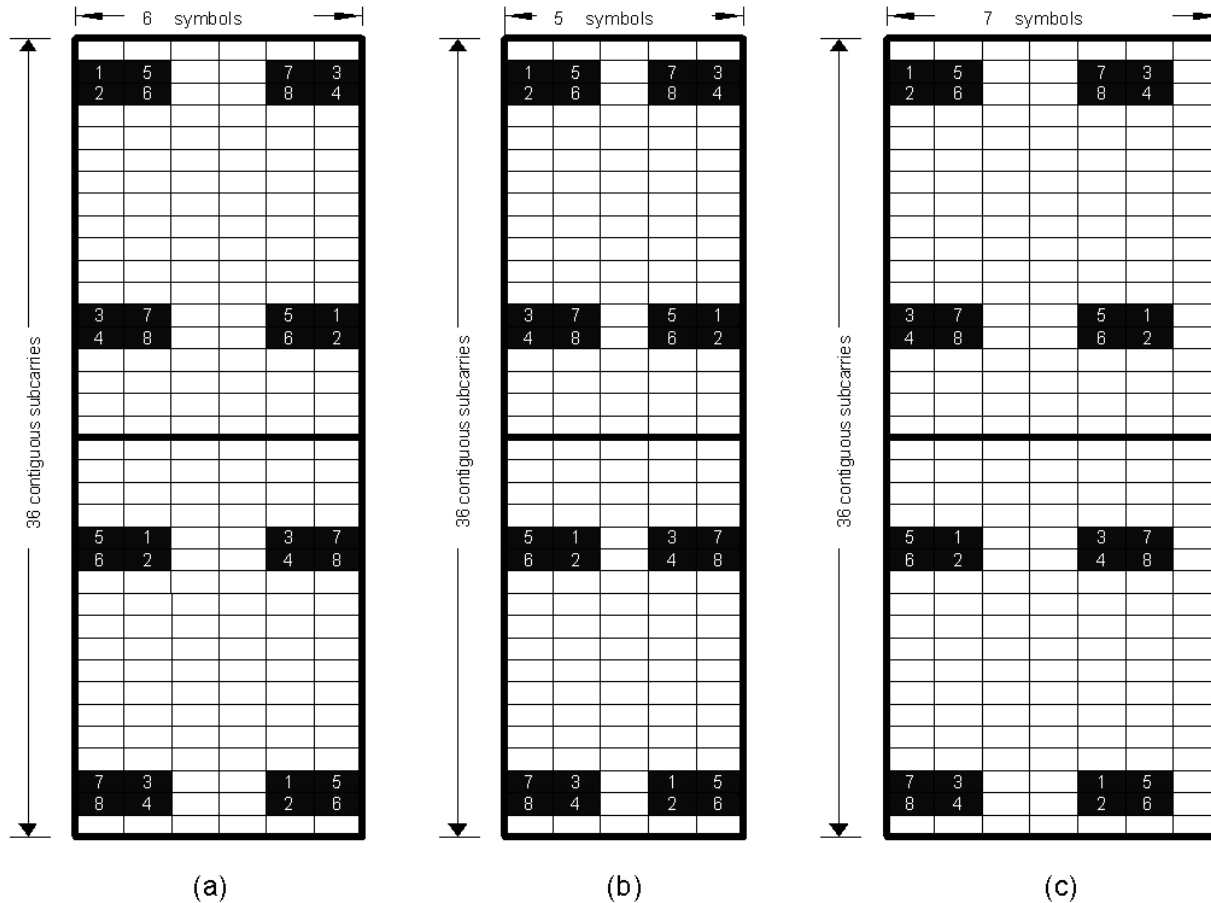

PILOT PATTERN FOR EIGHT TX STREAMS

# Pilot Interlacing Concept

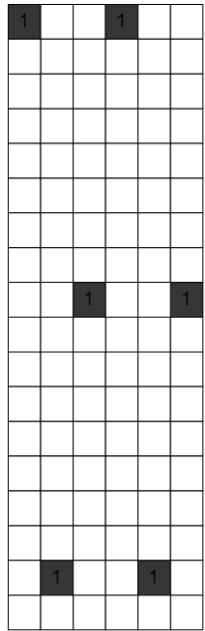

Pilot # 0

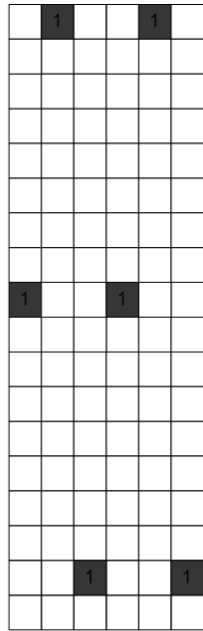

Pilot #1

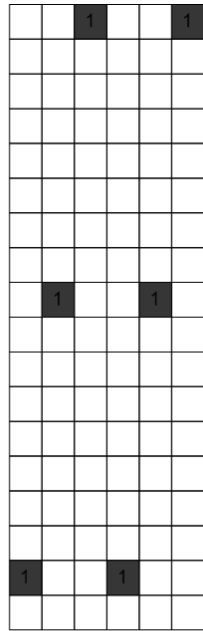

Pilot #2

Interlaced Pilots for 1 Stream

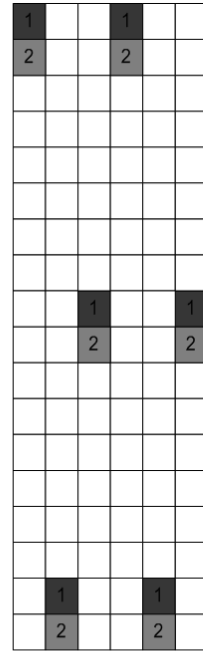

Pilot #0

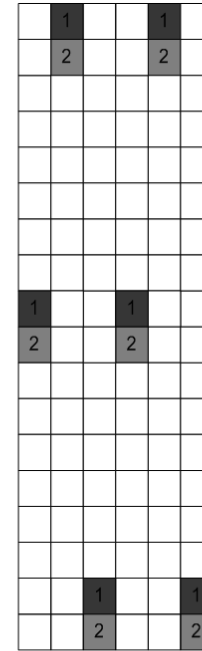

Pilot #1

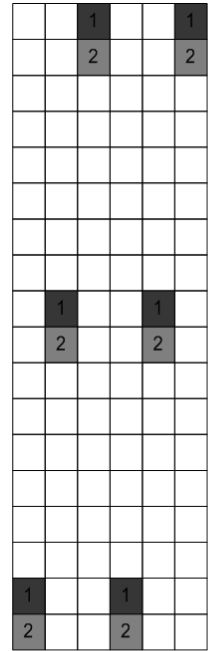

Pilot #2

Interlaced Pilots for 2 Streams

To overcome the effects of pilot interference among the neighboring sectors or base stations, an interlaced pilot structure is utilized by cyclically shifting the base pilot pattern such that the pilots of neighboring cells do not overlap

# **HARQ Protocols and Timing**

# IEEE 802.16m HARQ Operation

- IEEE 802.16m uses adaptive asynchronous and non-adaptive synchronous HARQ schemes in the downlink and uplink, respectively.
- The HARQ operation is relying on an N-process (multi-channel, N=16) stop-and-wait protocol.
- In adaptive asynchronous HARQ, the resource allocation and transmission format for the HARQ retransmissions may be different from the initial transmission.
- In case of retransmission, control signaling is required to indicate the resource allocation and transmission format along with other HARQ necessary parameters.
- A non-adaptive synchronous HARQ scheme is used in the uplink where the parameters and the resource allocation for the retransmission are known a priori.

# HARQ Operation and Timing

## Downlink (FDD/TDD)

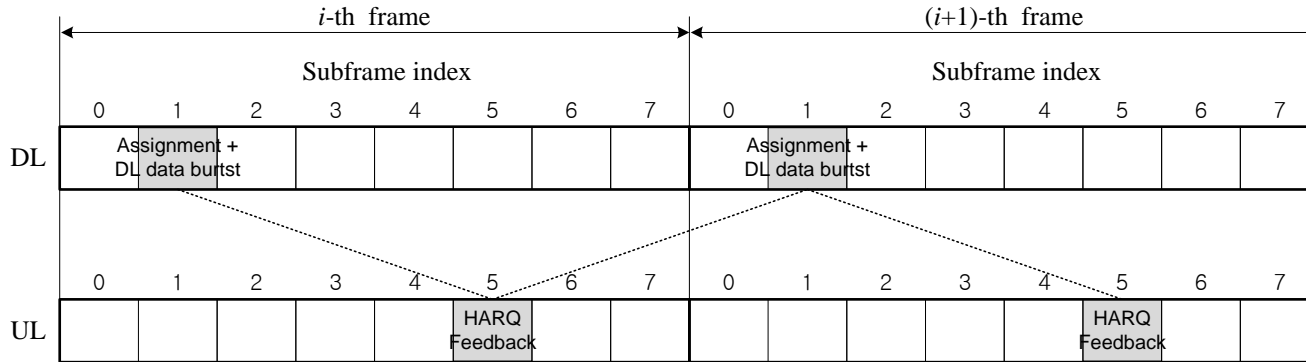

EXAMPLE FDD DL HARQ TIMING FOR 5, 10 AND 20 MHZ CHANNEL BANDWIDTHS

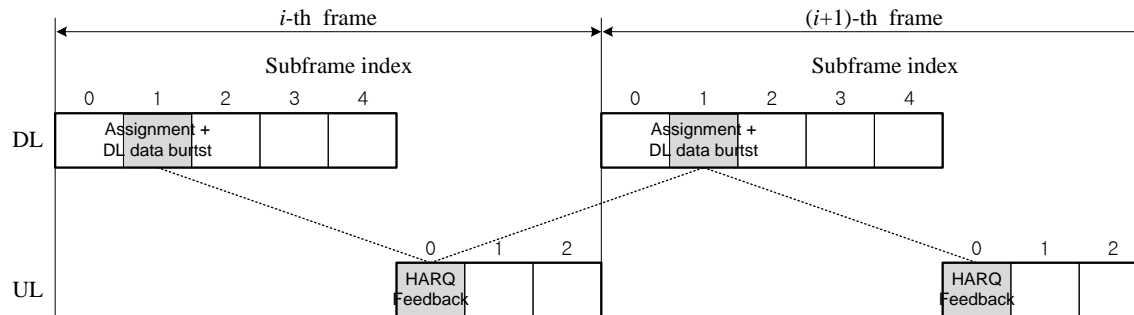

EXAMPLE TDD DL HARQ TIMING FOR 5, 10 AND 20 MHZ CHANNEL BANDWIDTHS

# HARQ Operation and Timing

## Uplink (FDD/TDD)

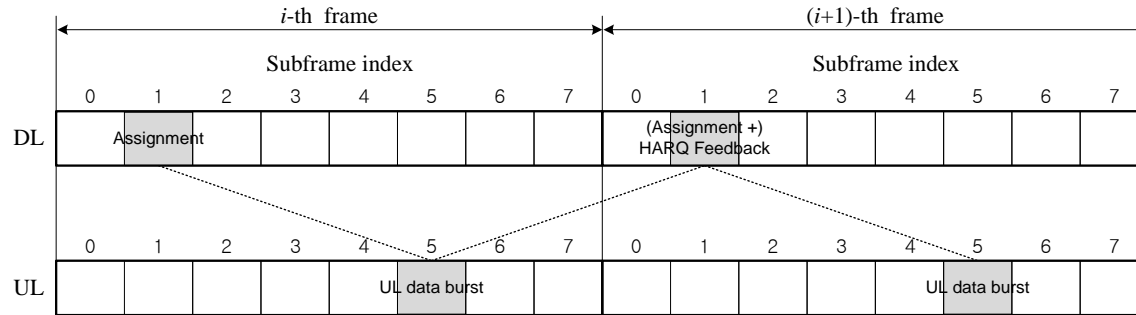

EXAMPLE FDD UL HARQ TIMING FOR 5, 10 AND 20 MHZ CHANNEL BANDWIDTHS

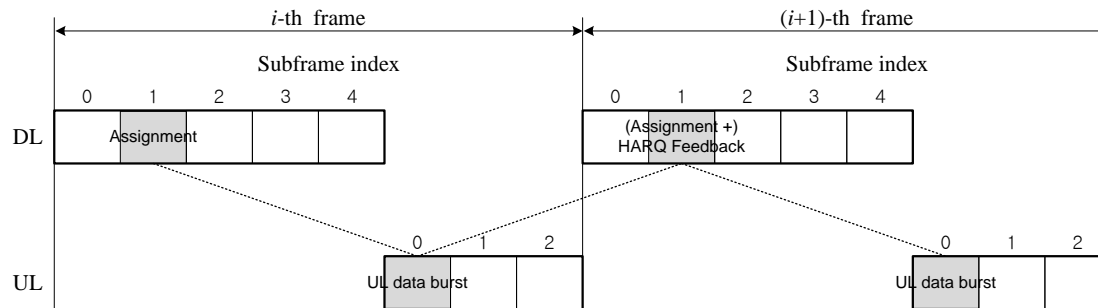

EXAMPLE TDD UL HARQ TIMING FOR 5, 10 AND 20 MHZ CHANNEL BANDWIDTHS

# HARQ Timing (TDD DL/UL 5:3)

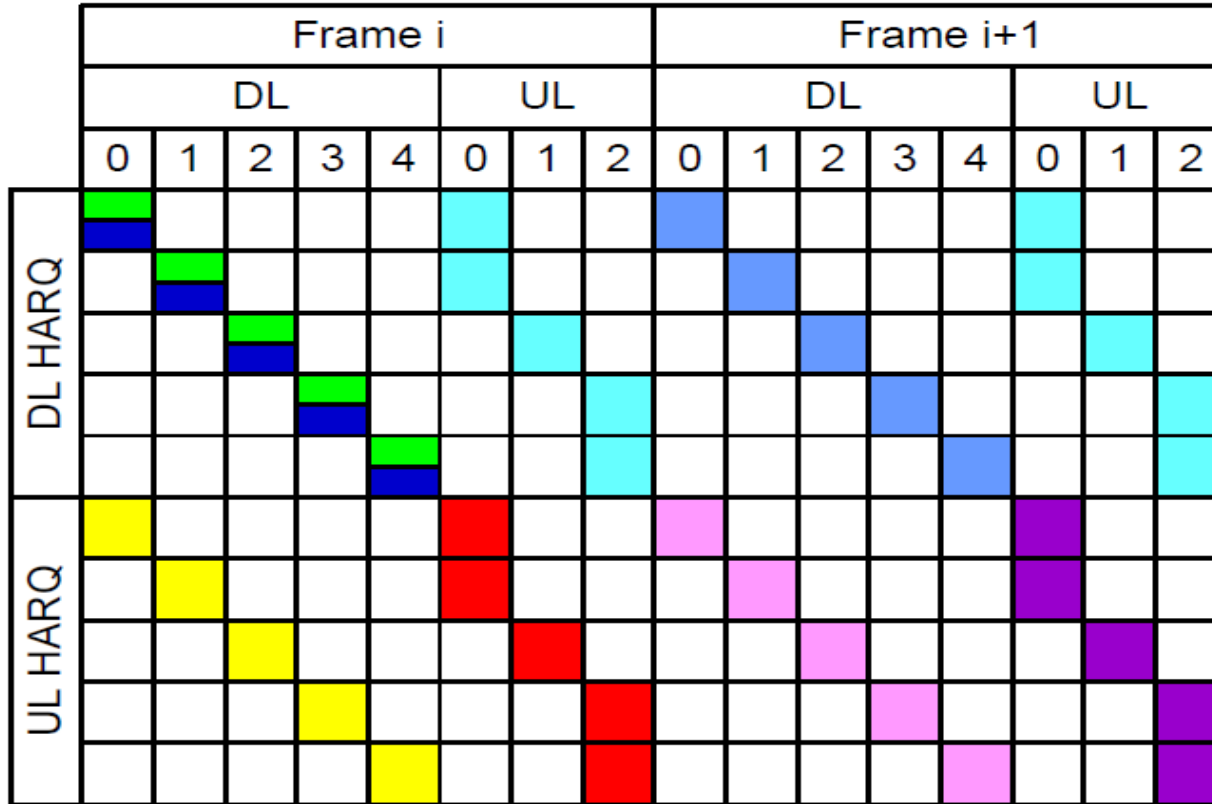

- A-MAP for DL
- DL Data 1<sup>st</sup> TX
- Feedback for DL
- DL Data ReTx (example)
- A-MAP for UL
- UL Data 1<sup>st</sup> TX
- Feedback for UL
- UL Data ReTx

# **Downlink/Uplink MIMO Schemes**

# IEEE 802.16mDL/UL MIMO Schemes

- Key features of IEEE 802.16m DL MIMO
  - Single-BS and Multi-BS MIMO
  - Single-User MIMO (SU-MIMO) and Multi-User MIMO (MU-MIMO)
    - Vertical encoding for SU-MIMO and Horizontal encoding for MU-MIMO
  - Adaptive-precoding (closed loop) and non-adaptive (open loop) MIMO precoding
  - Codebook and sounding based precoding
    - Short and long term adaptive precoding as well as Dedicated (precoded) pilots for MIMO operation
  - Enhanced codebook design
    - Enhanced base codebook, Transformed codebook, Differential codebook
- Key features of IEEE 802.16m UL MIMO
  - Single-User MIMO (SU-MIMO) and Collaborative Spatial Multiplexing (CSM)
  - Vertical encoding for SU-MIMO and CSM
  - Open Loop and Closed Loop MIMO operation
  - Codebook based and vendor specific precoding
    - Short and Long term precoding as well as Precoded (dedicated) pilots for MIMO operation
  - Enhanced codebook design
    - Enhanced base codebook for both correlated and uncorrelated channel
    - Antenna selection codewords to reduce MS power consumption

# IEEE 802.16m DL MIMO Classification

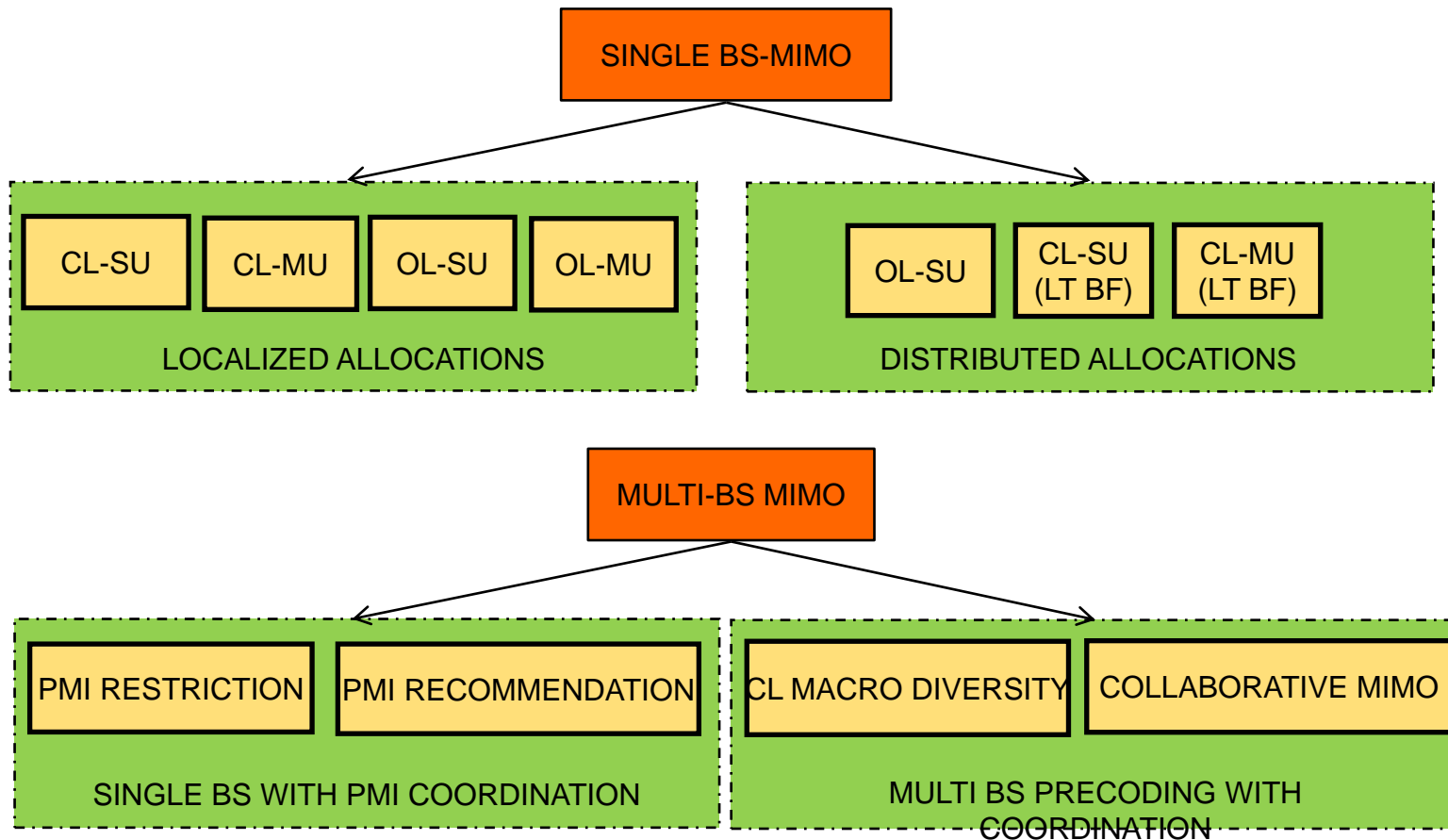

# Downlink/Uplink MIMO Architectures

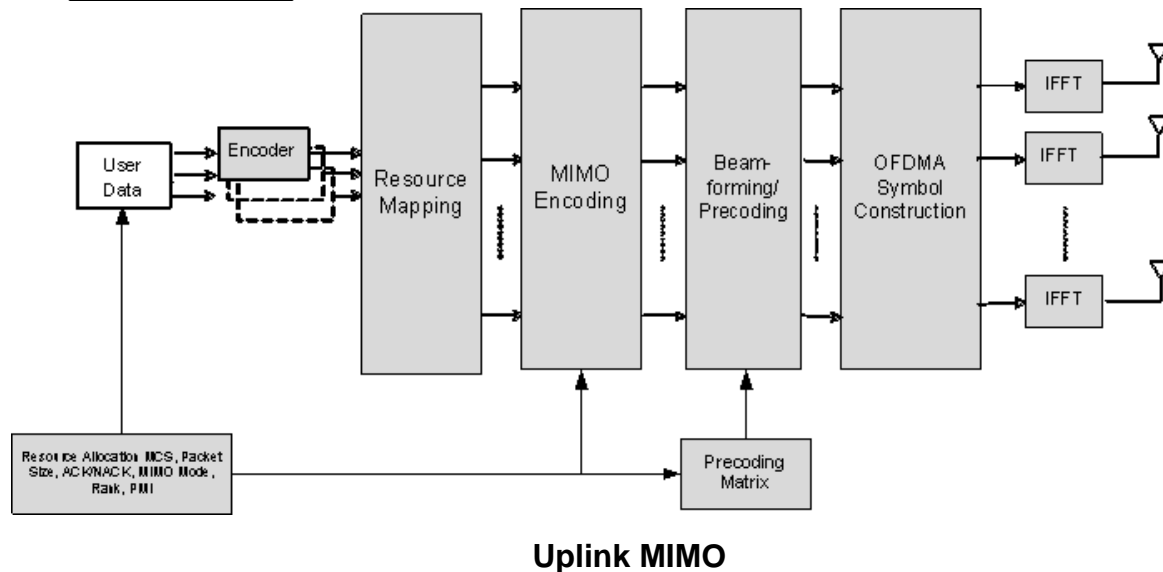
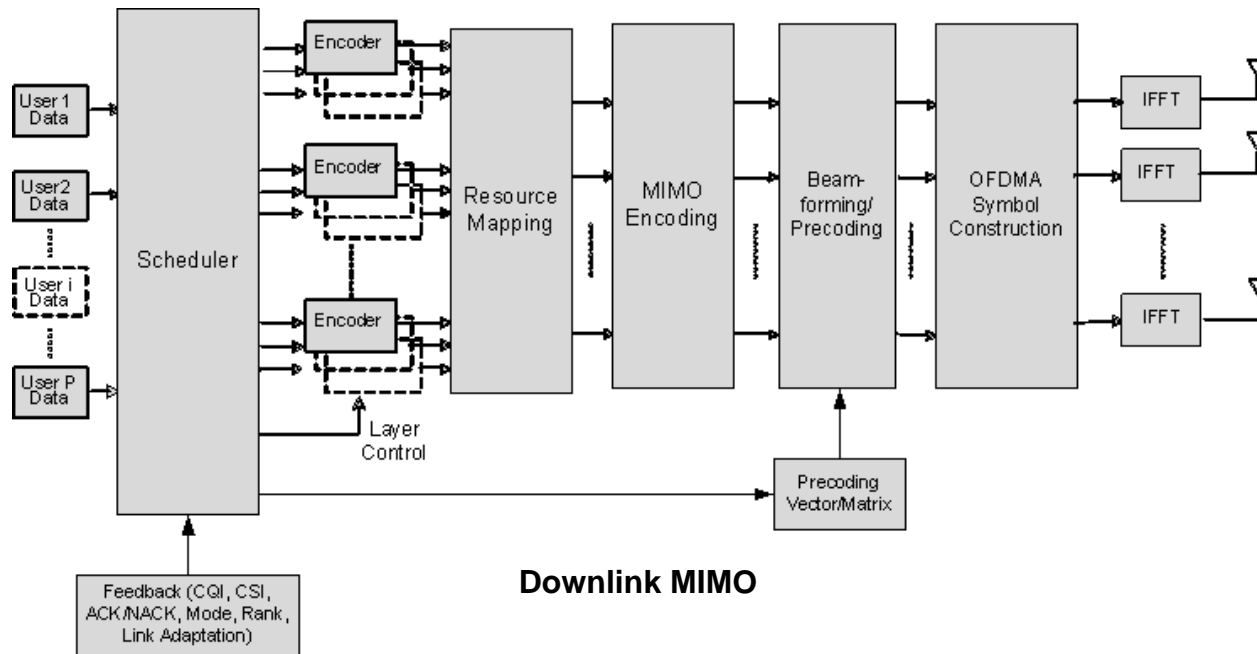

# Downlink MIMO Modes

MODE INDEX	DESCRIPTION	MIMO ENCODING FORMAT (MEF)	MIMO PRECODING
MODE 0	OL SU-MIMO	SFBC	NON-ADAPTIVE
MODE 1	OL SU-MIMO (SM)	VERTICAL ENCODING	NON-ADAPTIVE
MODE 2	CL SU-MIMO (SM)	VERTICAL ENCODING	ADAPTIVE
MODE 3	OL MU-MIMO (SM)	HORIZONTAL ENCODING	NON-ADAPTIVE
MODE 4	CL MU-MIMO (SM)	HORIZONTAL ENCODING	ADAPTIVE
MODE 5	OL SU-MIMO (TX DIVERSITY)	CONJUGATE DATA REPETITION (CDR)	NON-ADAPTIVE

	# OF TX ANTENNAS	STC RATE PER LAYER	# OF STREAMS	# OF SUBCARRIERS	# OF LAYERS
<b>MIMO MODE 0</b>	2	1	2	2	1
	4	1	2	2	1
	8	1	2	2	1
<b>MIMO MODE 1 AND MIMO MODE 2</b>	2	1	1	1	1
	2	2	2	1	1
	4	1	1	1	1
	4	2	2	1	1
	4	3	3	1	1
	4	4	4	1	1
	8	1	1	1	1
	8	2	2	1	1
	8	3	3	1	1
	8	4	4	1	1
	8	5	5	1	1
	8	6	6	1	1
	8	7	7	1	1
8	8	8	1	1	
<b>MIMO MODE 3 AND MIMO MODE 4</b>	2	1	2	1	2
	4	1	2	1	2
	4	1	3	1	3
	4	1	4	1	4
	8	1	2	1	2
	8	1	3	1	3
<b>MIMO MODE 5</b>	8	1	4	1	4
	2	1/2	1	2	1
	4	1/2	1	2	1
	8	1/2	1	2	1

# Uplink MIMO Modes

MODE INDEX	DESCRIPTION	MIMO ENCODING FORMAT	MIMO PRECODING
MODE 0	OL SU-MIMO	SFBC	NON-ADAPTIVE
MODE 1	OL SU-MIMO (SM)	VERTICAL ENCODING	NON-ADAPTIVE
MODE 2	CL SU-MIMO (SM)	VERTICAL ENCODING	ADAPTIVE
MODE 3	OL MU-MIMO (COLLABORATIVE SM)	VERTICAL ENCODING	NON-ADAPTIVE
MODE 4	CL MU-MIMO (COLLABORATIVE SM)	VERTICAL ENCODING	ADAPTIVE

	NUMBER OF TRANSMIT ANTENNAS	STC RATE PER LAYER	NUMBER OF STREAMS	NUMBER OF SUBCARRIERS	NUMBER OF LAYERS
<b>MIMO MODE 0</b>	2	1	2	2	1
	4	1	2	2	1
<b>MIMO MODE 1 AND MIMO MODE 2</b>	2	1	1	1	1
	2	2	2	1	1
	4	1	1	1	1
	4	2	2	1	1
	4	3	3	1	1
	4	4	4	1	1
<b>MIMO MODE 3 AND MIMO MODE 4</b>	2	1	1	1	1
	4	1	1	1	1
	4	2	2	1	1
	4	3	3	1	1

# DL MIMO Open-loop Region

- OL MIMO Region is a pre-allocated MIMO zone dedicated for open-loop MIMO transmission
  - OL region is aligned across all cells
  - Static interference inside OL Region improves accuracy of CQI measurements for link adaptation and covariance matrix estimation for interference mitigation
  - CQI is estimated using precoded pilots
  - Three types of OL region

	<b>Maximum # of Streams</b>	<b>MIMO MODE</b>	<b>SUPPORTED PERMUTATION</b>
OL Region Type 0	2 streams	MIMO Mode 0 MIMO Mode 1 ( $M_t = 2$ streams)	DRU
OL Region Type 1	1 stream	MIMO Mode 5 ( $M_t = 1$ streams)	Mini-band based CRU (diversity allocation) Sub-band based CRU (localized allocation)
OL Region Type 2	2 streams	MIMO Mode 1 ( $M_t = 2$ streams) MIMO Mode 3 ( $M_t = 2$ streams)	Sub-band based CRU (localized allocation)

# SU-MIMO Base Codebook

- Base codebook for 2 TX antennas
  - 3 bits codebook for adaptive precoding
  - codebook subset for non-adaptive precoding
- Base codebook for 4 TX antennas
  - 6 bits codebook (4 bits subset) for adaptive precoding
  - codebook subset for non-adaptive precoding
- Base codebook for 8 TX antennas
  - 4 bits codebook for adaptive precoding
  - codebook subset for non-adaptive precoding

## MIMO Feedback

- UL control channel
  - Allocated using Feedback Allocation A-MAP IE
  - One PFBCH or SFBCH per MS
- UL MAC header and MAC control message
  - Allocated using Polling A-MAP IE
  - Maximum 4 header/message per user
- Most reports are based on mid-amble measurements, except measurements on OL region pilots

# MIMO Midamble

- MIMO midamble is used for PMI selection and CQI estimation
- MIMO midamble is transmitted every frame on the first symbol of DL subframe
- Physical structure
  - Reuse 3
  - Low PAPR Golay sequence
  - 2dB boosting
  - Antenna rotation to break periodic properties

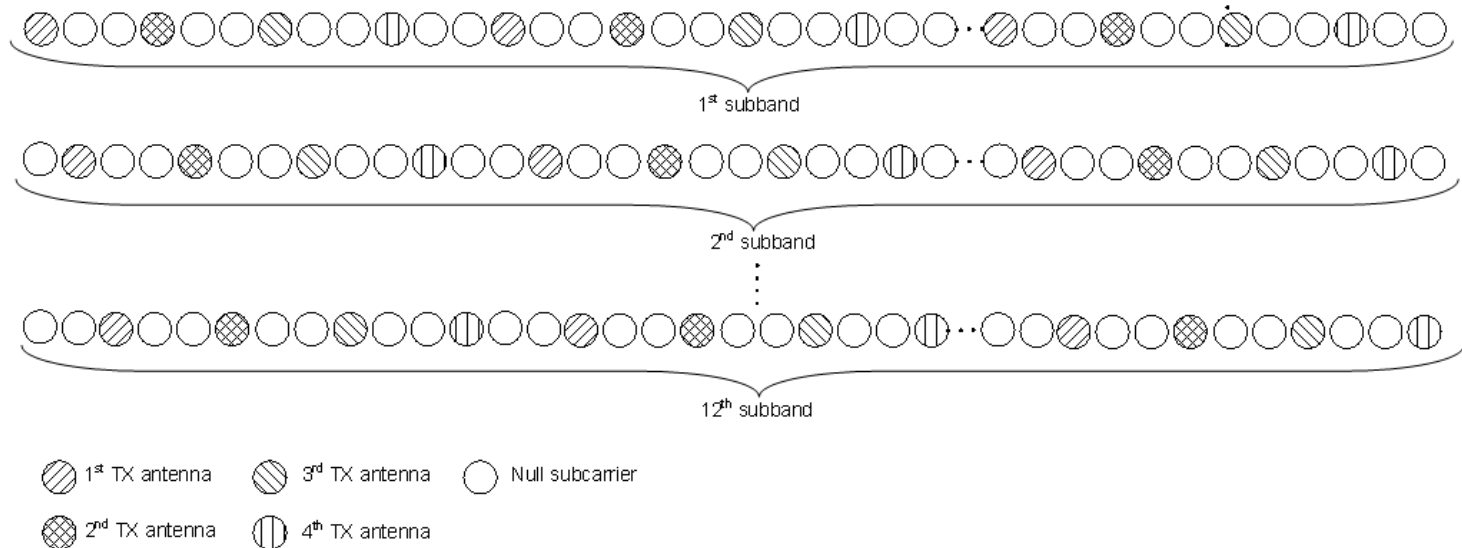

# **Modulation and Coding**

# Modulation and Coding

- Convolutional Turbo Code (CTC) with code rate 1/3
  - FEC block sizes ranging from 48 to 4800
  - Bit grouping: solve the 64QAM degradation problem
  - FEC CRC and burst CRC
- Burst size signaling
  - A small set of burst sizes and simple concatenation rule
  - Rate matching -> continuous code rate
- Control channels (DL: SFH and A-A-MAP; UL: SFBCH and BW-REQ) FEC is based on TBCC
  - Minimal code rate is 1/4 for DL and 1/5 for UL
  - Random puncturing with sub-block interleaver and rate-matching
- HARQ coding
  - HARQ-IR
    - 4 SPID defined for DL, signaled in A-MAP
    - Contiguous transmission in UL
  - CoRe: 2 versions for 16QAM and 64QAM
    - DL: CoRe version signaled in A-MAP
    - UL: CoRe version change when circular buffer wrap around

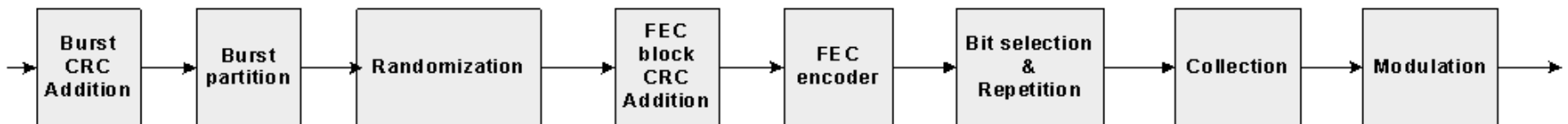

# Modulation and Coding

INDEX	BURST SIZE (BYTE)	# OF FEC BLOCKS	INDEX	BURST SIZE (BYTE)	# OF FEC BLOCKS	INDEX	BURST SIZE (BYTE)	# OF FEC BLOCKS
1	6	1	23	90	1	45	1200	2
2	8	1	24	100	1	46	1416	3
3	9	1	25	114	1	47	1584	3
4	10	1	26	128	1	48	1800	3
5	11	1	27	145	1	49	1888	4
6	12	1	28	164	1	50	2112	4
7	13	1	29	181	1	51	2400	4
8	15	1	30	205	1	52	2640	5
9	17	1	31	233	1	53	3000	5
10	19	1	32	262	1	54	3600	6
11	22	1	33	291	1	55	4200	7
12	25	1	34	328	1	56	4800	8
13	27	1	35	368	1	57	5400	9
14	31	1	36	416	1	58	6000	10
15	36	1	37	472	1	59	6600	11
16	40	1	38	528	1	60	7200	12
17	44	1	39	600	1	61	7800	13
18	50	1	40	656	2	62	8400	14
19	57	1	41	736	2	63	9600	16
20	64	1	42	832	2	64	10800	18
21	71	1	43	944	2	65	12000	20
22	80	1	44	1056	2	66	14400	24

# **Downlink Synchronization and Control Channels**

# Structure of the DL Synchronization Channels

- Primary Advanced Preamble
  - One symbol per superframe
  - Super frame synchronization
  - Initial acquisition (timing/carrier recovery)
- Secondary Advanced Preamble
  - Three symbols per superframe
  - Fine synchronization and cell identification

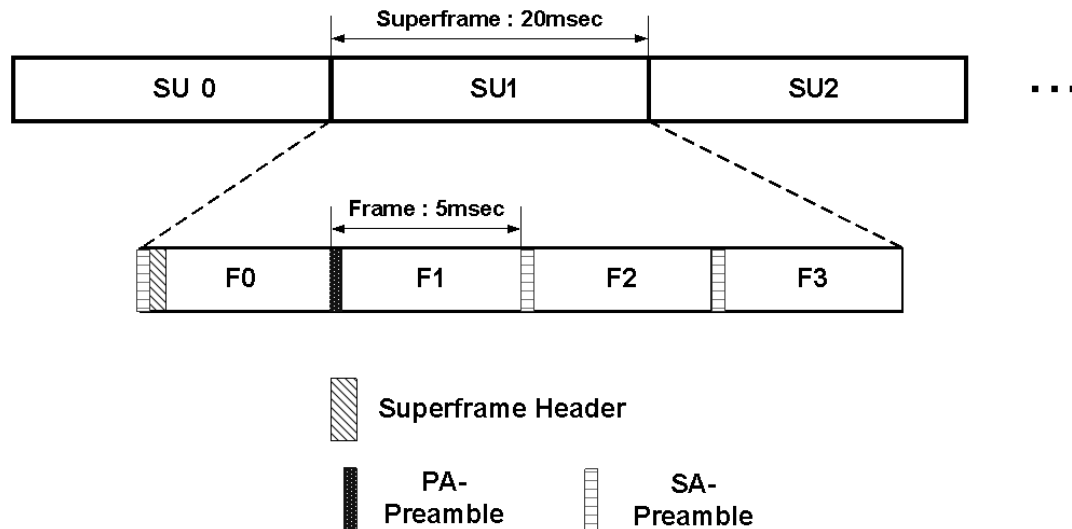

# Primary A-Preamble

- Fixed BW (5 MHz)
- 216 sequence length
- 11 binary sequences
- Reuse 1
- Every other subcarrier is null (2x repetition in time)
- Carries BW information
  - Index 0 : 5MHz, Index 1 : 7, 8.75, 10 MHz
  - Index 2 : 20 MHz
  - Indices 3~9 : reserved
  - Index 10 : Partially configured carrier

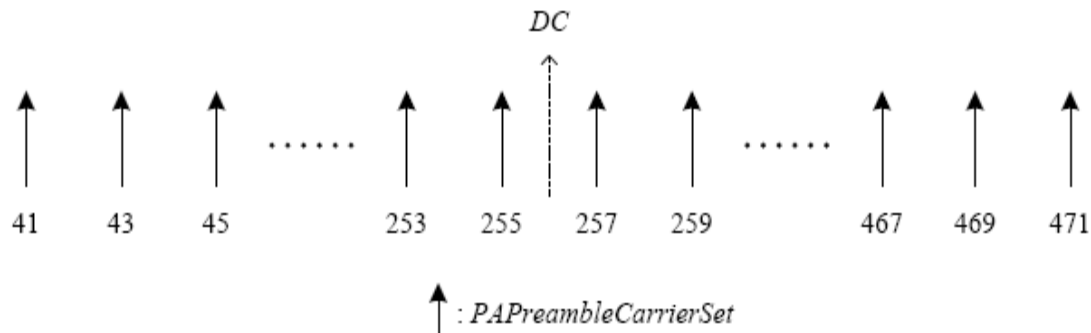

# Secondary A-Preamble

- Carries 768 cell IDs: 3x256
- QPSK
- Frequency reuse 3
- Scalable structure
  - Support multiple BW
    - 5 MHz composed of 8 sub-blocks
    - 10 MHz composed of 16 sub-blocks (repeat 5MHz preamble)
  - Support Tone dropping for irregular BW
  - Support multiple TX antenna
- Block cyclic shift avoid the ambiguity of legacy preamble detection

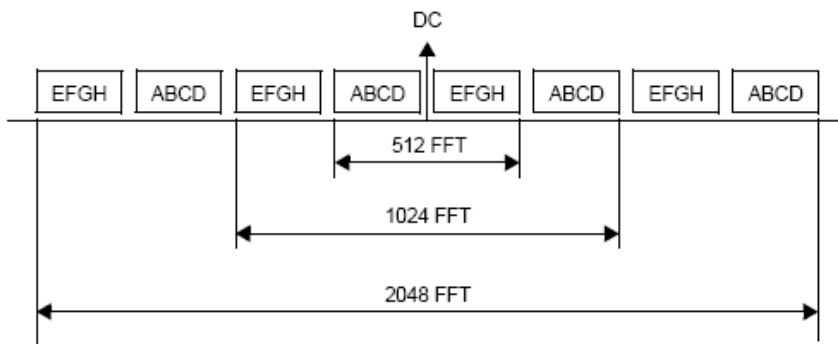

Allocation of Sequence Blocks for each FFT Size

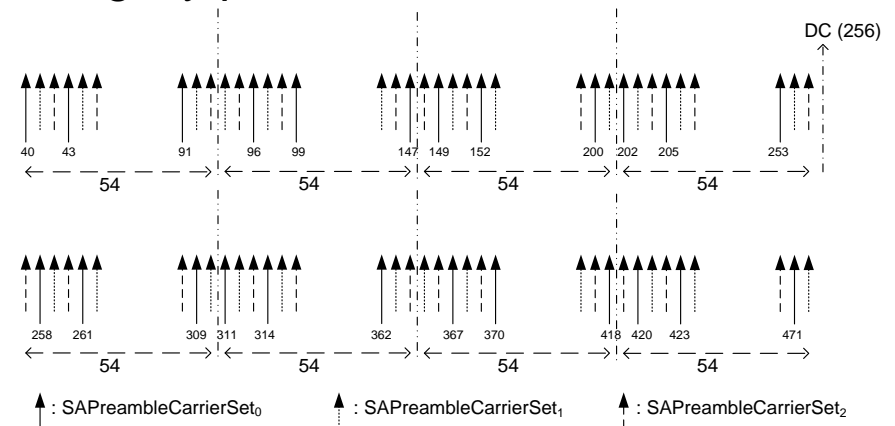

SA-Preamble Symbol Structure for 512 Point FFT

# Superframe Header (Broadcast Channel)

- SFH is located in the first subframe of every superframe. The first subframe of every superframe always has 6 symbols. The first symbol is occupied by SA-Preamble. SFH occupies the last 5 symbols of the subframe.
- The SFH subframe has only one frequency partition. All LRUs in the subframe are distributed LRUs with 2 stream pilots.
- P-SFH is transmitted every superframe and occupies the first few DLRUs of the subframe.
- P-SFH is transmitted using a fixed MCS: QPSK and an effective code rate of 1/24 using  $\frac{1}{4}$  TBCC as the mother code. The IE size of P-SFH is fixed. Therefore the physical resource (number of LRUs) occupied by P-SFH is fixed.
- AMS can decode P-SFH after obtaining system bandwidth and permutation information from PA-Preamble and SA-Preamble detection.
- S-SFH takes DLRUs after P-SFH and has a variable size, depending on the MCS and S-SFH sub-packet to be transmitted.

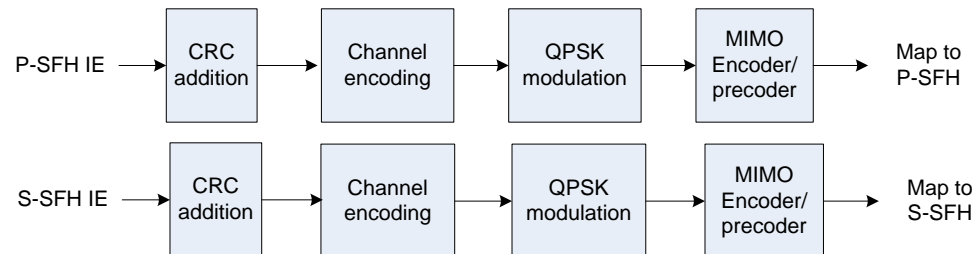

# Superframe Header (Broadcast Channel)

- After decoding P-SFH, AMS acquires the MCS and sub-packet information of S-SFH, from which AMS can derive the LRUs occupied by S-SFH and start decoding.
- SFBC and QPSK are used for both P-SFH and S-SFH.
- Total resource occupied by SFH is no more than 24 LRUs. However 4 to 6 LRUs need to be reserved for A-MAP in the 5 MHz system bandwidth case.
- P-SFH IE: It contains information regarding S-SFH sub-packet number, transmission format, and S-SFH change count/bitmap.
- S-SFH sub-packet 1: network re-entry information. It is transmitted once every two superframes.
- S-SFH sub-packet 2: initial network entry and network discovery information. It is transmitted once every four superframes.
- S-SFH sub-packet 3: remaining essential system information. The frequency of transmission is not determined but should be more than four superframes.
- At most one S-SFH sub-packet is transmitted in a superframe.

# Superframe Header Content (informative)

SFH IE Type	Content
P-SFH IE	LSB of Superframe number, S-SFH change count, S-SFH Size, S-SFH Number of Repetitions, S-SFH Scheduling information bitmap, S-SFH SP change bitmap
S-SFH SP1	Start superframe offset, MSB of superframe number, LSB of 48 bit ABS MAC ID, Number of UL ACK/NACK channels, Number of UL ACK/NACK channels, Power control channel resource size, Non-user specific A-MAP location, A-A-MAPMCS selection, DL permutation configuration, UL permutation configuration, Unsync ranging allocation interval channel information, Unsync ranging location in the frame, RNG codes information, Ranging code subset/ partition, ABS EIRP, Cell bar information

SFH IE Type	Content
S-SFH SP2	Start superframe offset, Frame configuration index, UL carrier frequency, UL bandwidth, MSB bytes of 48 bit ABS MAC ID, MAC protocol revision, FFR partitioning info for DL region, FFR partitioning info for UL region, AMS Transmit Power Limitation Level, EIRPIR_min
S-SFH SP3	Start superframe offset, Rate of change of SP, SA-sequence soft partitioning, FFR partition resource metrics, N1 information for UL power control, UL Fast FB Size, # Tx antenna, SP scheduling periodicity, HO Ranging backoff start, HO Ranging backoff end, Initial ranging backoff start, Initial ranging backoff end, UL BW REQ channel information, Bandwidth request backoff start, Bandwidth request backoff end, Uplink AAI subframe bitmap for sounding, Sounding multiplexing type (SMT) for sounding, Decimation value D/ Max Cyclic Shift Index P for sounding

# A-MAP Region

- An A-MAP region is composed of one or all of the following A-MAPs: non user-specific A-MAP, HARQ feedback A-MAP, power control A-MAP, and assignment A-MAP.
- There is at most one A-MAP region in a frequency partition.
- An A-MAP region occupies a number of logically contiguous DLRUs.
- There is at least one A-MAP region in each DL subframe.
- Information in the A-MAP region is coded and transmitted using SFBC.
- If FFR configuration is used, both the reuse 1 partition and the highest-power reuse 3 partition may have an A-MAP region.
- In a DL subframe, non user-specific, HARQ feedback, and power control A-MAPs are in a frequency partition called the primary frequency partition.
- The primary frequency partition can be either the reuse 1 partition or the highest-power reuse 3 partition, which is indicated by ABS through SFH.
- Assignment A-MAP can be in the reuse 1 partition or the highest-power reuse 3 partition or both.

# A-MAP Region Location and Structure

A-MAP	A-MAP	A-MAP	A-MAP				
DL SF0	DL SF1	DL SF2	DL SF3	UL SF4	UL SF5	UL SF6	UL SF7

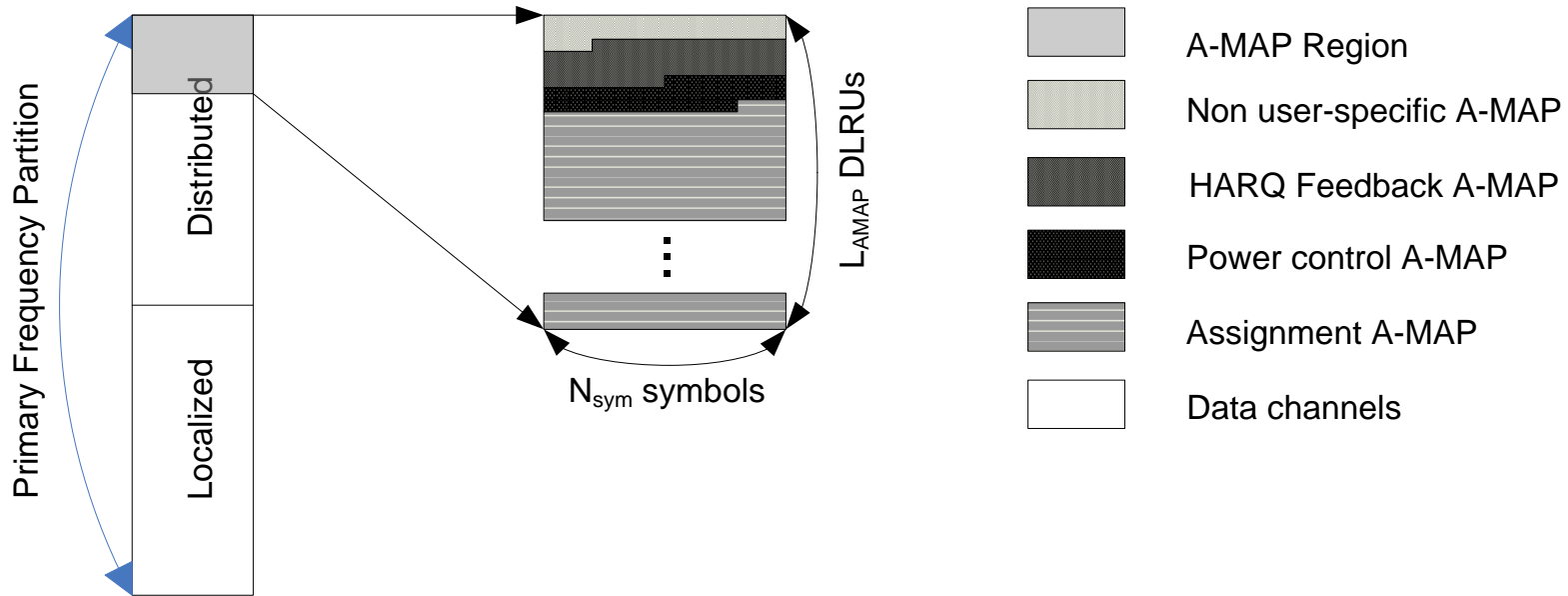

# A-MAP Physical Channel Tone-Selection

- A-MAP physical channels are formed by selecting tone-pairs from DLRUs in the A-MAP region.
- Tone-pairs of DLRUs in the A-MAP region are rearranged into a one-dimensional array in the time first manner. An A-MAP channel are formed by tone-pairs in a segment of the array.

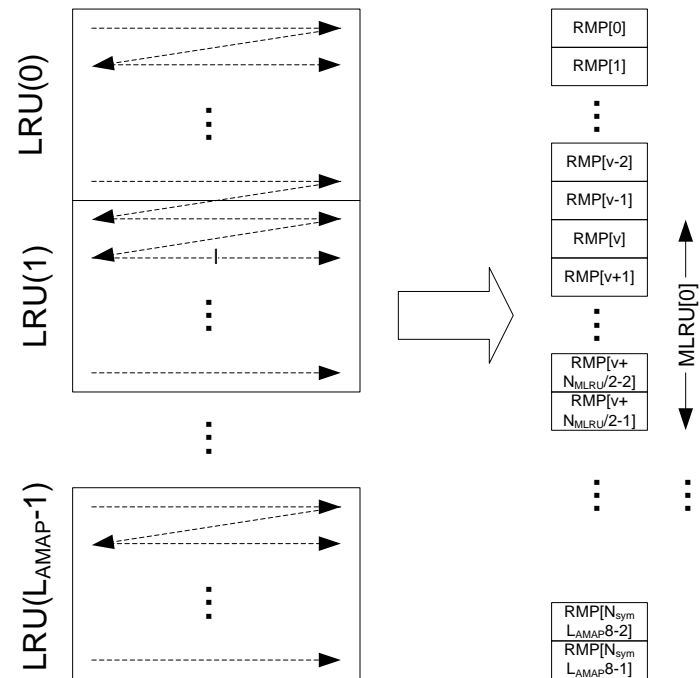

# Non User-Specific A-MAP

- The non user-specific A-MAP is the first A-MAP in the A-MAP region in the primary frequency partition.
- It has 12 information bits coded with  $1/12$  TBCC if the A-MAP region is in the reuse 1 partition, or with  $1/4$  TBCC if the A-MAP region is in the reuse 3 partition.

# HARQ Feedback A-MAP

- HARQ feedback A-MAP uses 8 tone-pairs as a cluster. Each cluster can carry up to 4 HF-A-MAP IEs.
- To reach cell edge users, BS can choose to transmit only one HF-A-MAP IE in a symbol (BPSK mode) before repetition.
- 8 LSBs of the STID are used to scramble the repeated HF-A-MAP IE before modulation in order to allow error handling of UL HARQ / persistent scheduling.

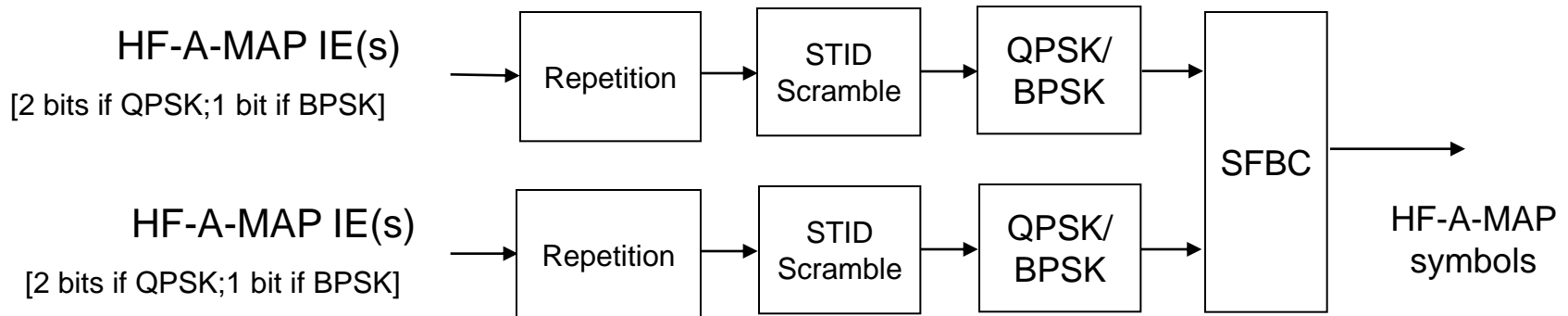

# Power Control A-MAP

- PC-A-MAP uses 2 tone-pairs (a PC-A-MAP cluster) to transmit up to 2 PC-A-MAP IEs.
- To reach cell edge users, BS can choose to transmit only one PC-A-MAP IE in a PC-A-MAP cluster.
- The first PC-A-MAP in the cluster occupies the real part of both symbols in each tone pair before the SFBC encoder. The second PC-A-MAP occupies the imaginary part of both symbols in each tone pair before the SFBC encoder.

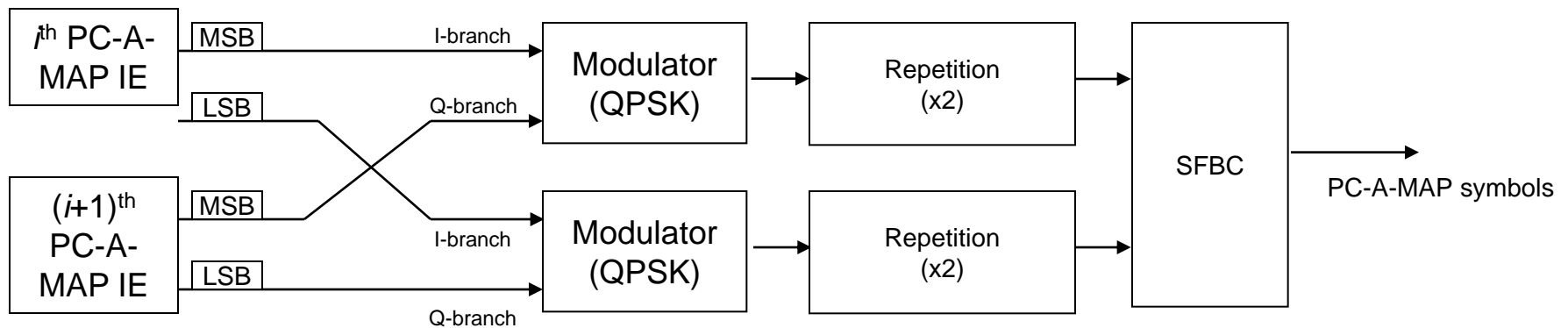

# Assignment A-MAP

- Each A-A-MAP takes one or multiple logical unit called MLRU, which is composed of 56 tones in a A-MAP region.
- MLRU is formed from DLRUs in the time first manner, starting from the first tone-pair available for A-A-MAP. Section 15.3.5.3.4 has details on MLRU formation.
- A-A-MAP IEs are either 56 bits or segmented to 56 bits so no rate matching is needed.
- A-A-MAP IEs are coded using a  $\frac{1}{4}$  TBCC mother code. In each subframe, A-A-MAP can be coded with two effective code rate:  $\frac{1}{2}$  and  $\frac{1}{4}$ , or  $\frac{1}{2}$  and  $\frac{1}{8}$ . S-SFH indicates which two effective code rates can be used.

# Assignment A-MAP Types (informative)

A-A-MAP IE Type	Usage
DL Basic Assignment	Allocation information for AMS to decode DL bursts using continuous logical resources
UL Basic Assignment	Allocation information for AMS to transmit UL bursts using continuous logical resources
DL sub-band Assignment	Allocation information for AMS to decode DL bursts using sub-band based resources
UL sub-band Assignment	Allocation information for AMS to transmit UL bursts using sub-band based resources
Feedback Allocation	Allocation or deallocation of UL fast feedback control channels to an AMS
UL Sounding Command	Control information for AMS to start UL sounding transmission
CDMA Allocation	Allocation for AMS requesting bandwidth using a ranging or bandwidth request codes
DL Persistent	DL persistent resource allocation
UL Persistent	UL persistent resource allocation
DL Group Resource Allocation	DL group scheduling and resource allocation
UL Group Resource Allocation	UL group scheduling and resource allocation
Feedback Polling	Allocation for AMS to send MIMO feedback using MAC messages or extended headers
BR-ACK	Indication of decoding status of bandwidth request opportunities and resource allocation of bandwidth request header
Broadcast	Broadcast burst allocation and other broadcast information

# Assignment A-MAP Blind Detection

- In IEEE 802.16m, A-A-MAP blind detection means the following
  - In most cases, MS needs to decode all MLRUs in an A-MAP region in order to know if there is any relevant A-A-MAP.
  - MS does not need to use different MCS to decode the same MLRU. Non user-specific A-MAP signals the MCS used by each MLRU.
  - MS does not need to decode MLRU using different rate de-matching for different IE sizes. All A-A-MAP IE or segmented IE have fixed size, i.e., 56 bits.
  - MS determines if an A-A-MAP is relevant or not by performing CRC test using STID (unicast), group ID (group scheduling), or RAID (CDMA allocation) to unmask CRC. If CRC test passes, MS continues parsing the content of the decoded A-A-MAP.

# **Uplink Control Channels**

# UL Control Channels

- Primary Fast feedback Channels
- Secondary Fast feedback Channels
- HARQ ACK/NACK feedback
- Bandwidth Request (BW-REQ)
- Ranging
- Sounding

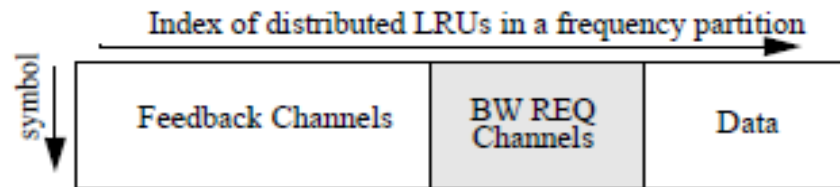

Allocation of UL control and data channels in the distributed LRUs of a frequency partition of an UL AAI subframe.

Figure 523—Allocation of channels in the UL frequency partition

# Fast Feedback Channels

- Primary and Secondary- Fast feedback Channels
  - Three 2x6 Feedback mini-tiles
  - Supported features: MIMO mode selection, Band selection, CQI, PMI, Event driven reports (buffers overflow, FFR group selection)

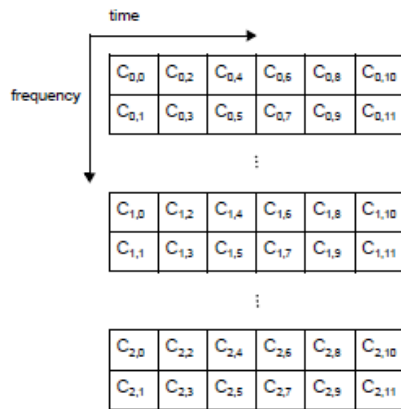

Figure 555—PFBCH comprised of three distributed 2x6 UL FMTs

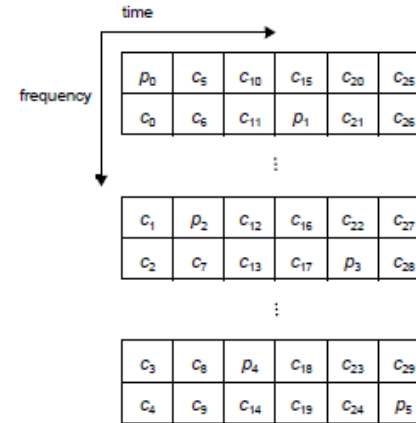

Figure 557—SFBCH comprising of three distributed 2x6 UL FMTs

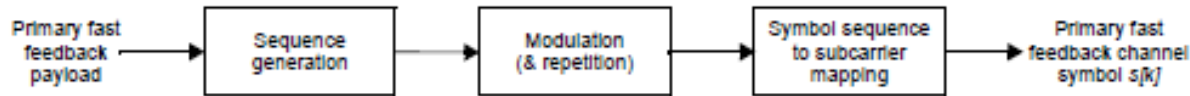

Figure 556—Mapping of information in the PFBCH

# BW-REQ, HARQ, Ranging and Sounding

- BW request
  - Three 6x6 UL-tiles (same as UL data tile)
  - Fast 3 stages BW-REQ, by attaching certain information (MS identification and required allocation size)
  - Fallback 5 stages BW-REQ
- HARQ Feedback
  - Each HF control CH contains 3 HARQ Mini-Tiles (HMT) sized 2x2 each & carry 2 HARQ feedback channels
  - 3 Reordered FMTs (2x6 each) → form 9 HMT → Up to 6 HARQ feedbacks.
- Ranging
  - Asynchronous with two formats, to support large cell sizes
  - Synchronous (incl. handover to Femto)
- Sounding
  - For UL CL MIMO and UL Scheduling

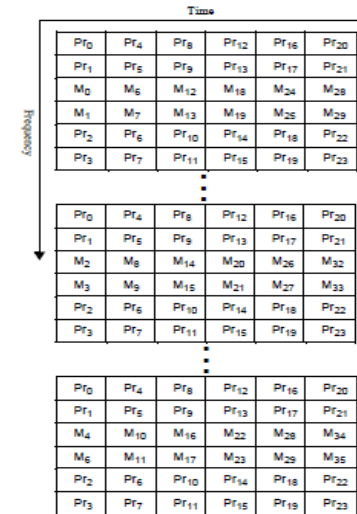

Figure 560—6x6 BR Tile Structure in the Advance Air Interface

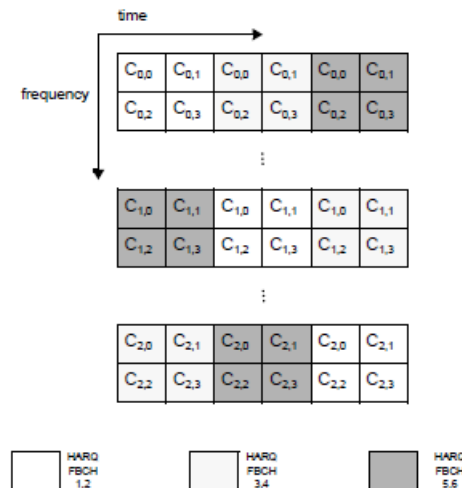

Figure 558—2x2 HMT structure

# UL Sounding Channel

- Uplink sounding is used to support sounding based DL MIMO in TDD mode and UL MIMO in TDD and FDD modes
- Uplink sounding channel occupies one OFDMA symbol in UL subframe
- Two MS multiplexing methods
  - Code division multiplexing
  - Frequency division multiplexing
- Low PAPR Golay baseline sequence
- Enhanced power control for sounding channel
- Sounding channel parameters are transmitted in System Configuration Descriptor and SFH SP-1 broadcast channels

# Ranging for Asynchronous Mobile Stations

- Two formats
  - Format 0: covers up to 18 km, 1 sub-band x 1 subframe, used for macro initial ranging and handover ranging
  - Format 1: covers up to 100 km, 1 sub-band x 3 subframes, used for macro initial ranging and handover ranging in very large cells
- Zadoff-Chu codes with cyclic shifts
- Ranging channel allocated by S-SFH. Handover ranging can also be allocated by A-MAP

Format	$T_{RCP}$	$T_{RP}$	$\Delta f_{RP}$	Resource	Coverage
IEEE 802.16m Format 0	$3.5T_g + T_b$	$2 \times 2T_b$	$\Delta f / 2$	1 sub-band x 1 subf	18 km
IEEE 802.16m Format 1	$3.5T_g + 7T_b$	$8T_b$	$\Delta f / 8$	1 sub-band x 3 subf	100 km

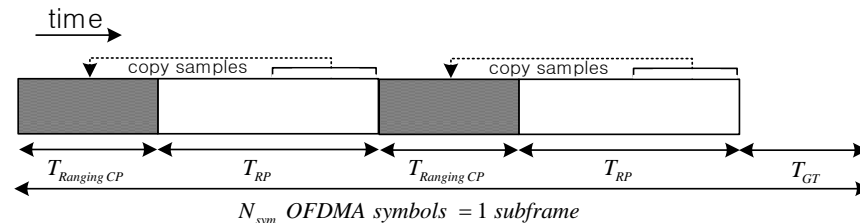

# IEEE 802.16m DL MIMO Feedback

## Long-term FB

STC\_Rate (indicates the preferred number of MIMO streams for SM; e.g., STC Rate 1 means SFBC with precoding)

Sub-band Index for best-M

Correlation Matrix R for Transform CB and long-term BF

Wideband CQI

Long-term PMI

## Short-term FB

Narrow band CQI for best-M

Sub-band Index for best-M

Short-term PMI for CL SU/MU MIMO

Stream Index for OL MU MIMO

## Event-driven FB

Preferred MIMO feedback mode

**IEEE 802.16m MAC CPS**

# MAC Addressing

- The AMS, ARS and ABS are identified by the globally unique 48-bit IEEE Extended Unique Identifier (EUI-48™) based on the 24-bit Organizationally Unique Identifier (OUI) value administered by the IEEE Registration Authority.
- IEEE 802.16m has two addressing identifiers instead of a CID
  - STID (12 bits): addressing of an MS
  - FID (4 bits): addressing the active service flows of the MS
- Some specific STIDs are reserved, for broadcast, multicast, and ranging
- The advantage is overhead reduction
  - STID is used in A-MAP
  - FID is only used in AGMH
    - Instead of 16-bit CID in the legacy system

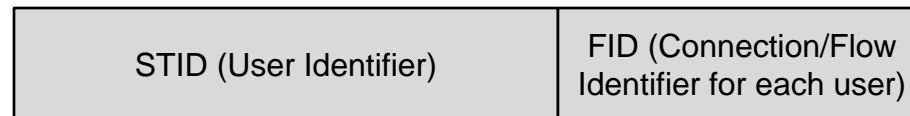

# MAC Headers

- Advanced Generic MAC Header (AGMH) for data transmission
- Extended Header (optional)
- AGMH is 2 Bytes in size
- Compact MAC Header (CMH) for smaller payloads
- Signaling Header (MAC header with no payload for signaling)

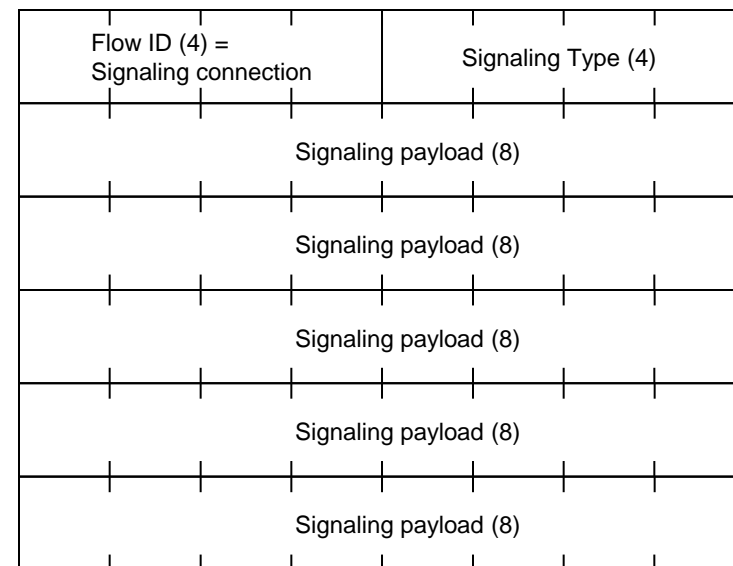
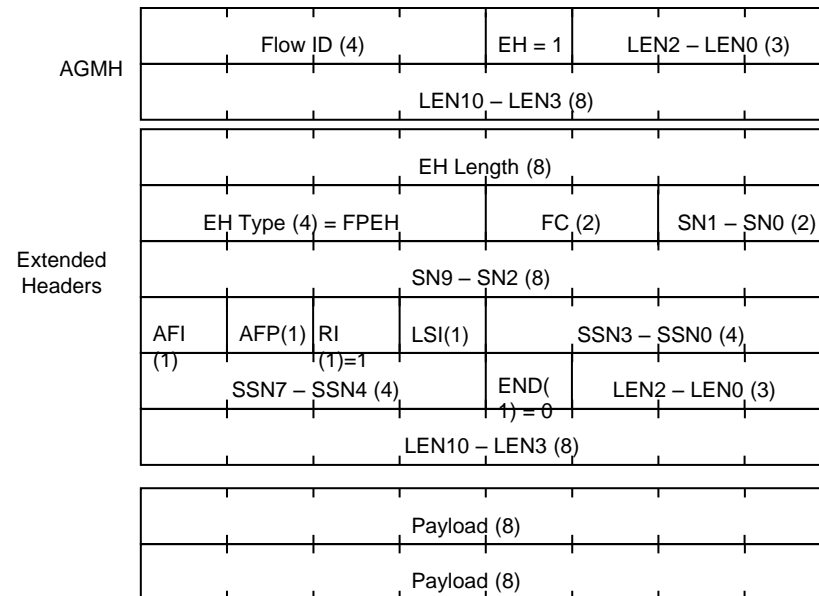
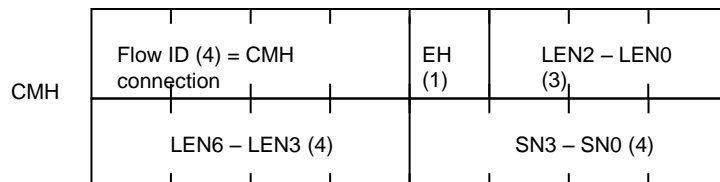
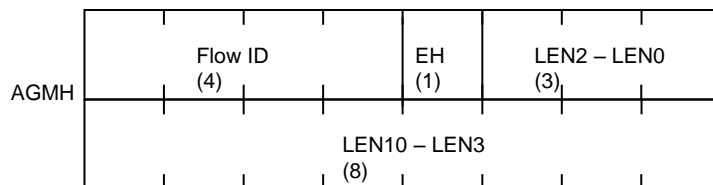

MAC Signaling Header

# MAC Control/Management Messages

- The peer-to-peer protocol of MAC layers in ABS and AMS communicate using the MAC control messages to perform the control plane functions.
- MAC control messages are contained in a MAC PDU that is transported over broadcast, unicast, or random access connections.
- There is a single unicast control connection
- HARQ is enabled for MAC control messages sent on the unicast control connection
- Encryption may be enabled for unicast MAC control messages.
- MAC control messages may be fragmented
- Encrypted and non encrypted MAC control messages are not sent in the same PDU
- All MAC management messages are ASN.1 encoded

# Inter-RAT L2 Message Transfer

- IEEE 802.16m provides a generic MAC management message called AAI\_L2-XFER. This acts as a generic service container for various services including, but not limited to
  - Device provisioning bootstrap message to AMS, GPS assistance delivery to AMS, ABS geo-location unicast delivery to AMS, IEEE 802.21 MIH transfer, messaging service, etc.
- This container is also used for IEEE 802.16m messages that are not processed by the ABS or ARS, rather are processed by network entities beyond the ABS.

# IEEE802.16m Security Architecture

- The IEEE 802.16m security architecture is divided into two logical entities
  - Security management entity
  - Encryption and integrity entity
- Security management entity functions include
  - Overall security management and control
  - EAP encapsulation/de-encapsulation
  - Privacy Key Management (PKMv3) which defines how to control all security components such as derivation/update/usage of keys
  - Authentication and Security Association (SA) control
  - Location privacy:
- Encryption and integrity protection entity functions included:
  - Transport data encryption/authentication processing
  - Control message authentication processing
  - Control message confidentiality protection

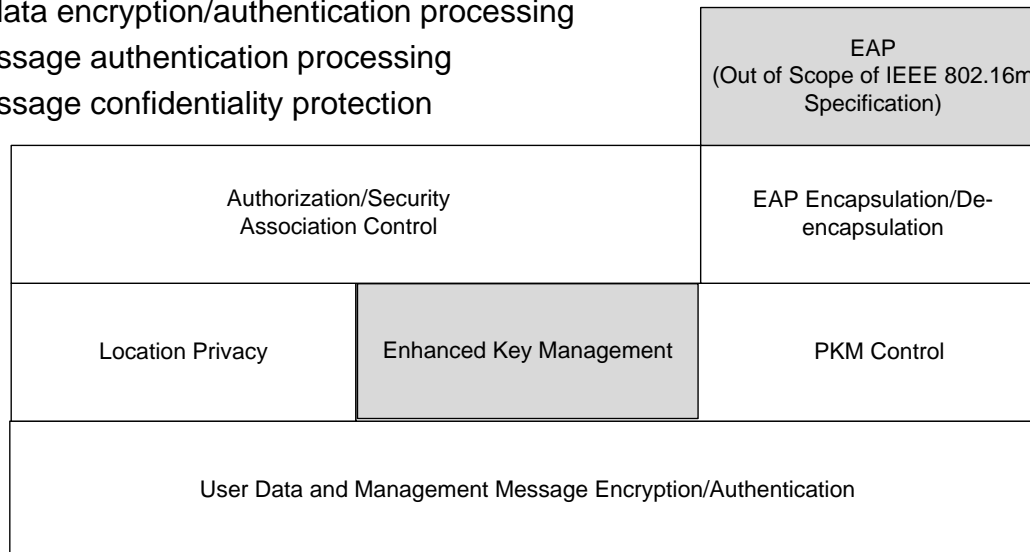

# IEEE802.16m Generic HO Signaling Procedure

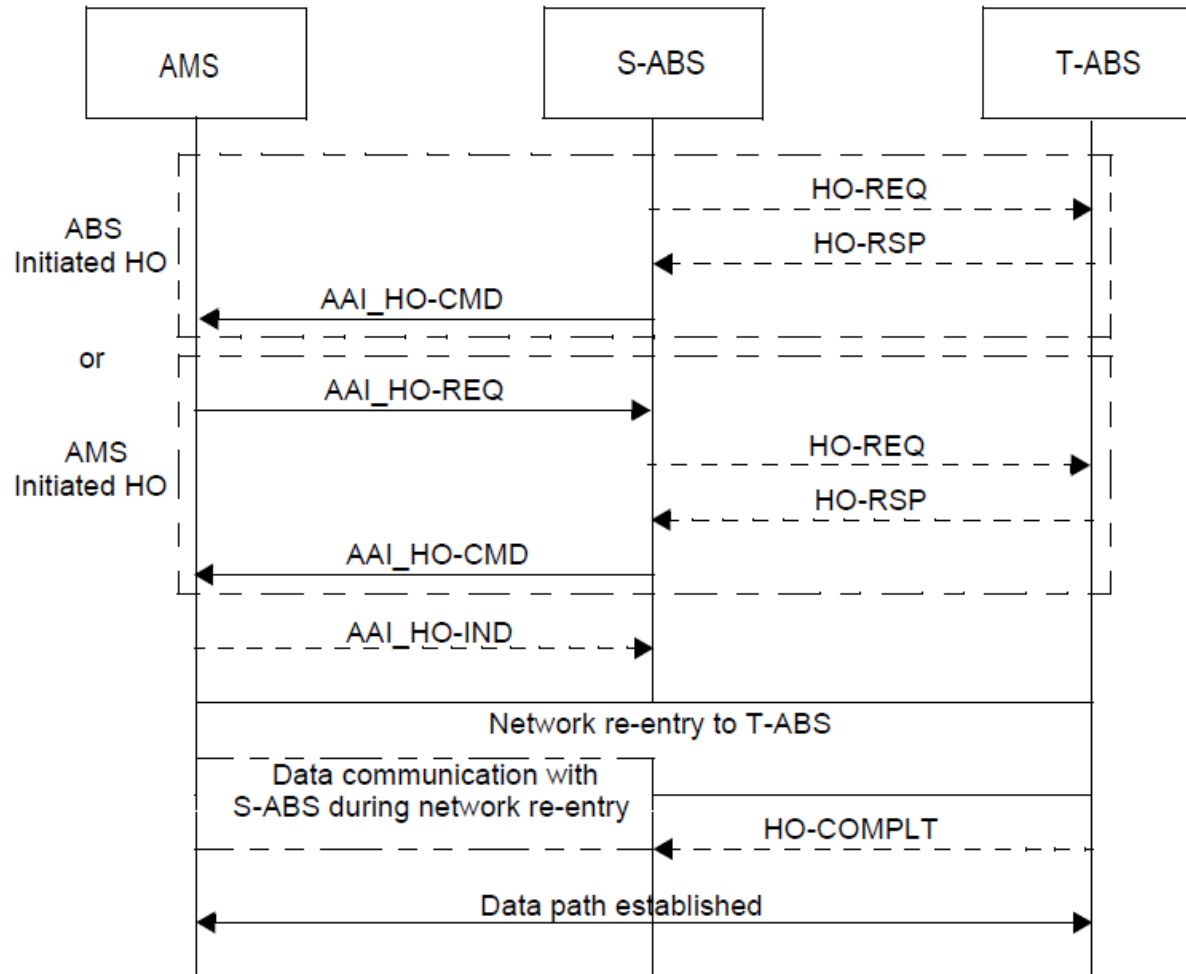

# Bandwidth Request Procedure

## Contention-based Random Access BW-REQ

5-step contention-based BW-REQ

BW-REQ preamble and Standalone BW-REQ header

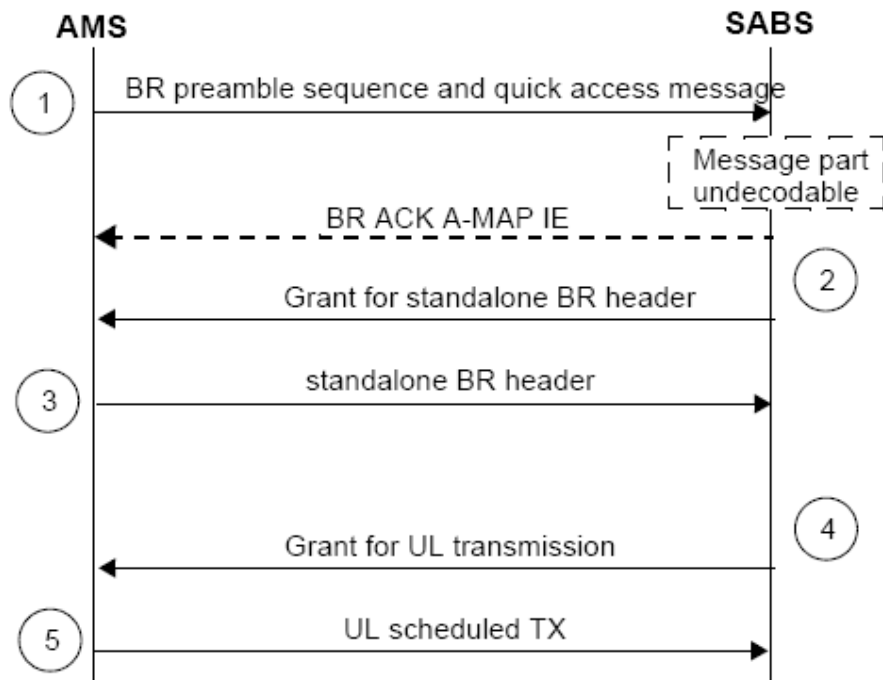

3-step contention-based BW-REQ

BW-REQ preamble + Quick access message

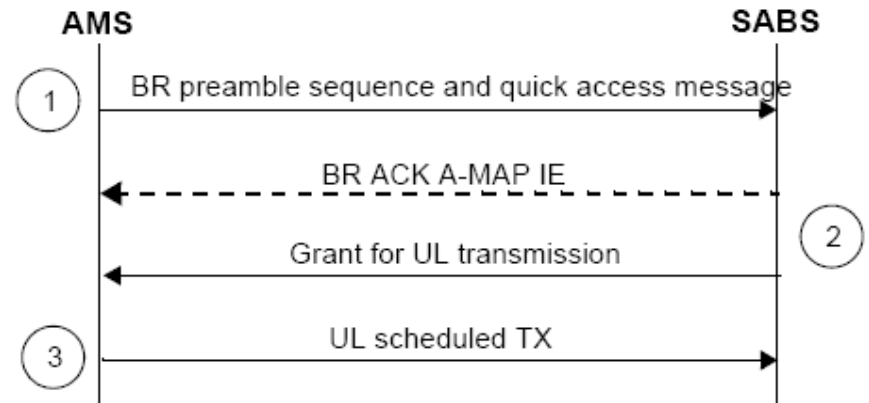

# IEEE 802.16m Mobile Station State Machine

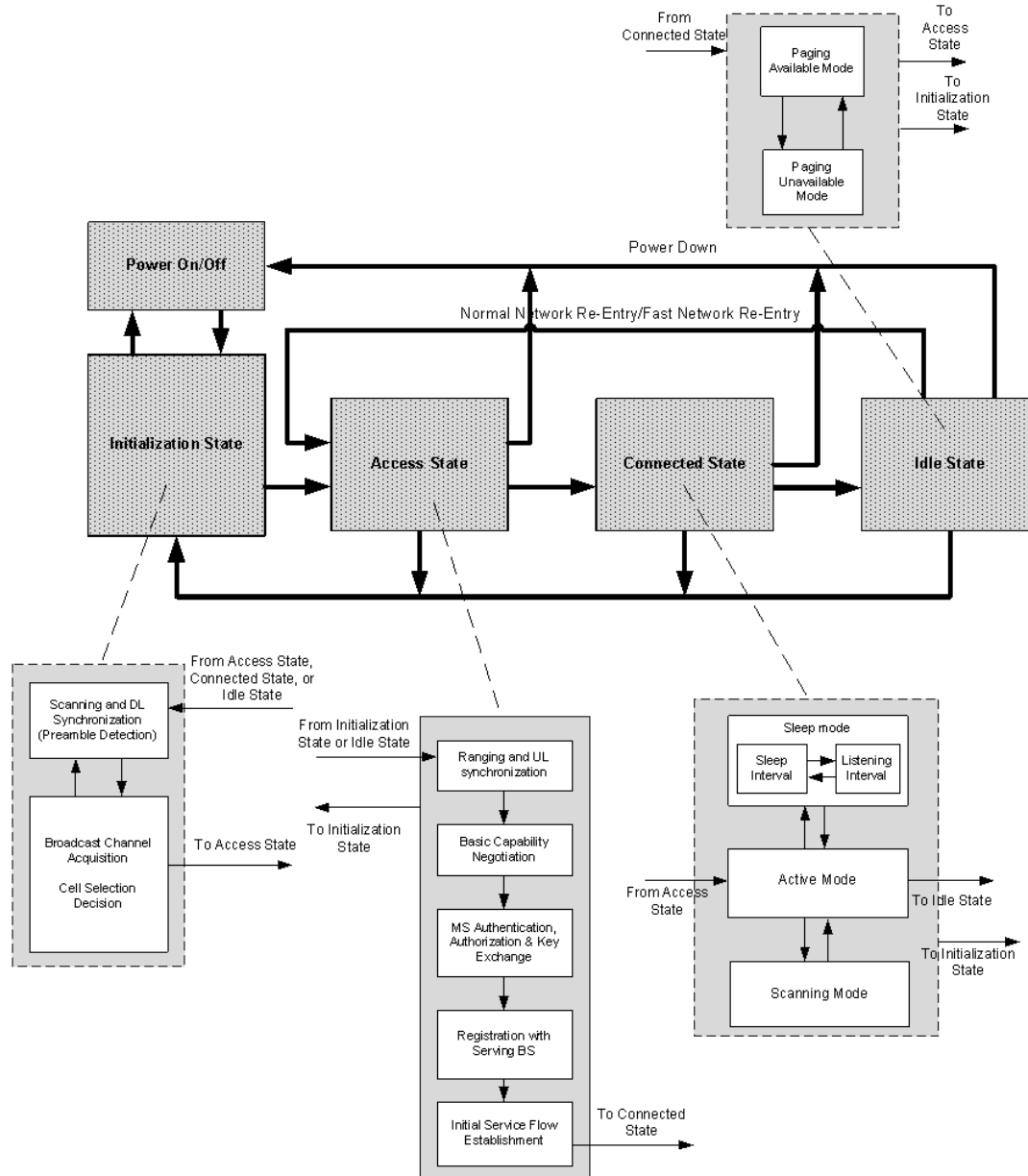

# Network Entry Procedure

- AMS uses pseudo MAC ID for Ranging
- AMS exposes actual MAC ID only after Authentication
- AMS obtains Temp STID (TSTID) until Registration with the ABS
- Actual STID assigned during Registration
- Initial transport service flow is also assigned by default during registration.

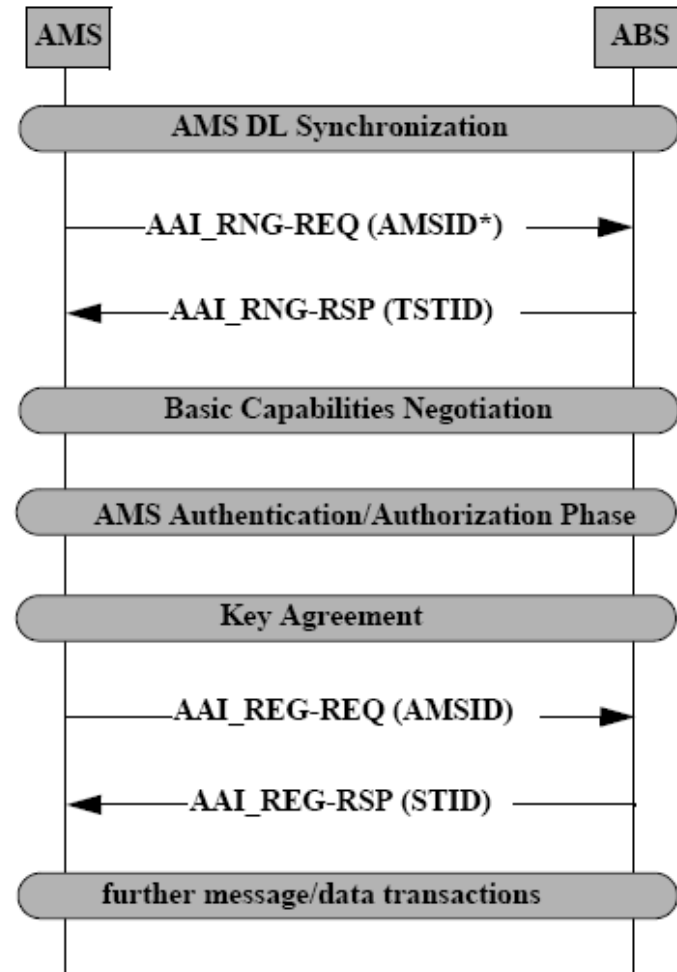

# Quality of Service

- IEEE 802.16m supports adaptation of service flow QoS parameters.
- One or more sets of QoS parameters are defined for one service flow.
- The AMS and ABS negotiate the supported QoS parameter sets during service flow setup procedure. When QoS requirement/traffic characteristics for DL/UL traffic change, the ABS may switch the service flow QoS parameters such as grant/polling interval or grant size based on predefined rules.
- The AMS may request the ABS to switch the service flow QoS parameter set with explicit signaling. The ABS then allocates resource according to the new service flow parameter set.

QoS Class	Applications	QoS Specifications
UGS Un-Solicited Grant Service	VoIP	Maximum sustained rate, Maximum latency tolerance, Jitter tolerance
rtPS Real-Time Packet Service	Streaming Audio, Video	Minimum Reserved Rate, Maximum Sustained Rate, Maximum Latency Tolerance, Traffic Priority
ertPS Extended Real-Time Packet Service	Voice with Activity Detection (VoIP)	Minimum Reserved Rate, Maximum Sustained Rate, Maximum Latency Tolerance, Jitter Tolerance, Traffic Priority
nrtPS Non-Real-Time Packet Service	FTP	Minimum Reserved Rate, Maximum Sustained Rate, Traffic Priority
BE Best-Effort Service	Data Transfer, Web Browsing	Maximum Sustained Rate, Traffic Priority
aGPS Adaptive Granting and Polling	Application Agnostic	Maximum Sustained Traffic Rate, the Request/Transmission Policy, Primary Grant and Polling Interval, Primary Grant Size

# ARQ Mechanism

- ARQ is per-connection basis and ARQ parameters are specified and negotiated during connection setup.
- A connection cannot have a mixture of ARQ and non-ARQ traffic.
- The scope of a specific instance of ARQ is limited to one unidirectional flow.
- An ARQ block is generated from one or multiple MAC SDU(s) or MAC SDU fragment(s) of the same flow.
- ARQ blocks can be variable in size.
- ARQ block is constructed by fragmenting MAC SDU or packing MAC SDUs and/or MAC SDU fragments.
- When transmitter generates a MAC PDU for transmission, MAC PDU payload may contain one or more ARQ blocks.
- The number of ARQ blocks in a MAC PDU payload is equal to the number of ARQ connections multiplexed in the MAC PDU.
- The ARQ blocks of a connection are sequentially numbered.

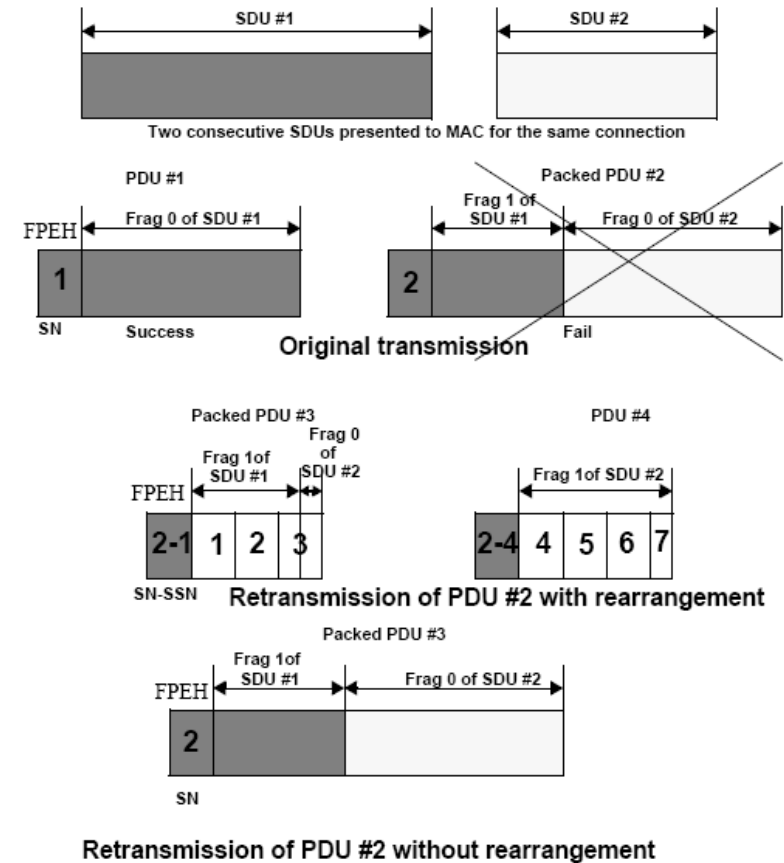

# Idle and Sleep Mode Management

## ▪ **Sleep Mode**

- An AMS in Sleep Mode conducts pre-negotiated periods of absence from the serving ABS
- A single power saving class is managed per AMS for all active connections of the AMS.
- Sleep mode may be activated when an AMS is in the Connected State. When Sleep Mode is active, the AMS is provided with a series of alternate listening window and sleep windows.
- The listening window is the time in which the AMS is available to exchange control signaling as well as data with the ABS.
- Sleep windows and listening windows can be dynamically adjusted for the purpose of data transportation as well as MAC control signaling transmission.
- The unit of sleep cycle is frames. The start of the listening window is aligned at the frame boundary.
- The AMS ensures that it has up-to-date system information for proper operation.
- A sleep cycle is the sum of a sleep window and a listening window. The AMS or ABS may request change of sleep cycle through explicit MAC control signaling.
- During the AMS listening window, ABS may transmit the traffic indication message intended for one or multiple AMSs according to the sleep negotiation messages.

## ▪ **Idle Mode**

- Idle Mode provides efficient power saving for the AMS by allowing the AMS to become periodically available for DL broadcast traffic messaging (e.g. Paging message) without registration at a specific ABS.
- The network assigns idle mode AMS to a paging group during Idle Mode entry or location update, minimizing the number of location updates by the AMS and the paging signaling overhead
- The ABSs and Idle Mode AMSs may belong to one or multiple paging groups
- The AMS monitors the paging message at AMS's paging listening interval. The start of the AMS's paging listening interval is derived based on paging cycle and paging offset. Paging offset and paging cycle are defined in terms of number of superframes.

# Paging Groups Example

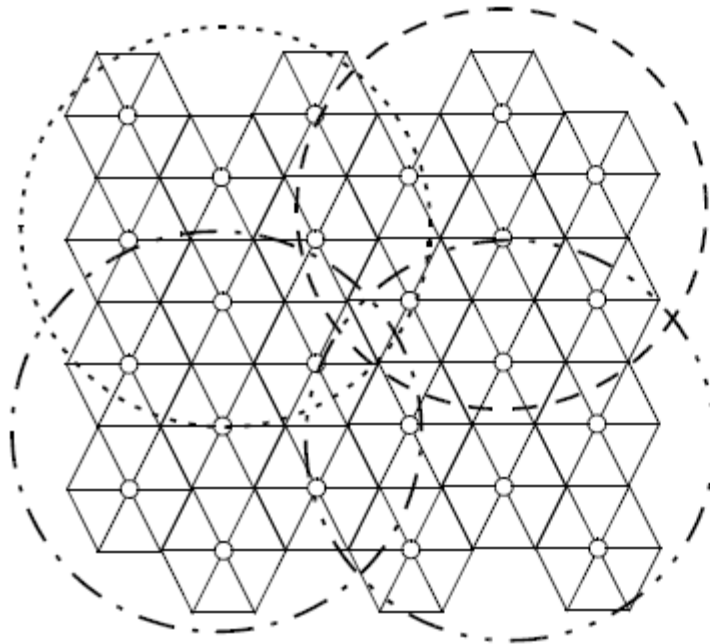

- ..... Paging group #1 .....
- - - - - Paging group #2 - - - - -
- . - . - . Paging group #3 - . - . - .
- . . . . - . Paging group #4 - . . . . - .

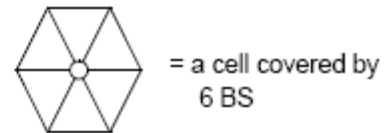

# **Support of Legacy Systems**

# Mixed-Mode Operation of IEEE 802.16m

## General Principles

- The legacy and new systems can simultaneously operate on the same RF carrier by dynamically sharing in time and/or frequency the radio resources over the frame.
- There are two approaches to support mixed mode operation of IEEE 802.16m and IEEE 802.16e
  - TDM of the DL zones and FDM of the UL zones (when UL PUSC is used in legacy UL)
  - TDM of the DL zones and TDM of the UL zones (when AMC is used in legacy UL)
- The UL link budget limitations of the legacy are considered in both UL approaches by allowing the legacy allocations to use the entire UL partition across time. The legacy and new allocations are frequency division multiplexed across frequency in both approaches.
- The synchronization, broadcast, and control structure of the two systems are mainly separated and these overhead channels present irrespective of the relative load of the network (i.e., the percentage of legacy and new terminals in the network). The size of the MAPs increase with the number of users.
- In TDD duplex scheme, the frame partitioning between DL and UL and the switching points are synchronized across the network to minimize inter-cell interference.
- The frame partitioning in IEEE 802.16m (superframe/frame/subframe) is transparent to the legacy BS and MS.
- The new BS or MS can fall back to the legacy mode when operating with a legacy MS or BS, respectively.
- While a number of upper MAC functions and protocols may be shared between legacy and new systems, most of the lower MAC and PHY functions and protocols are different or differently implemented (a dual-mode operation for support of legacy).

# Mixed-Mode Operation of IEEE 802.16m

## Example

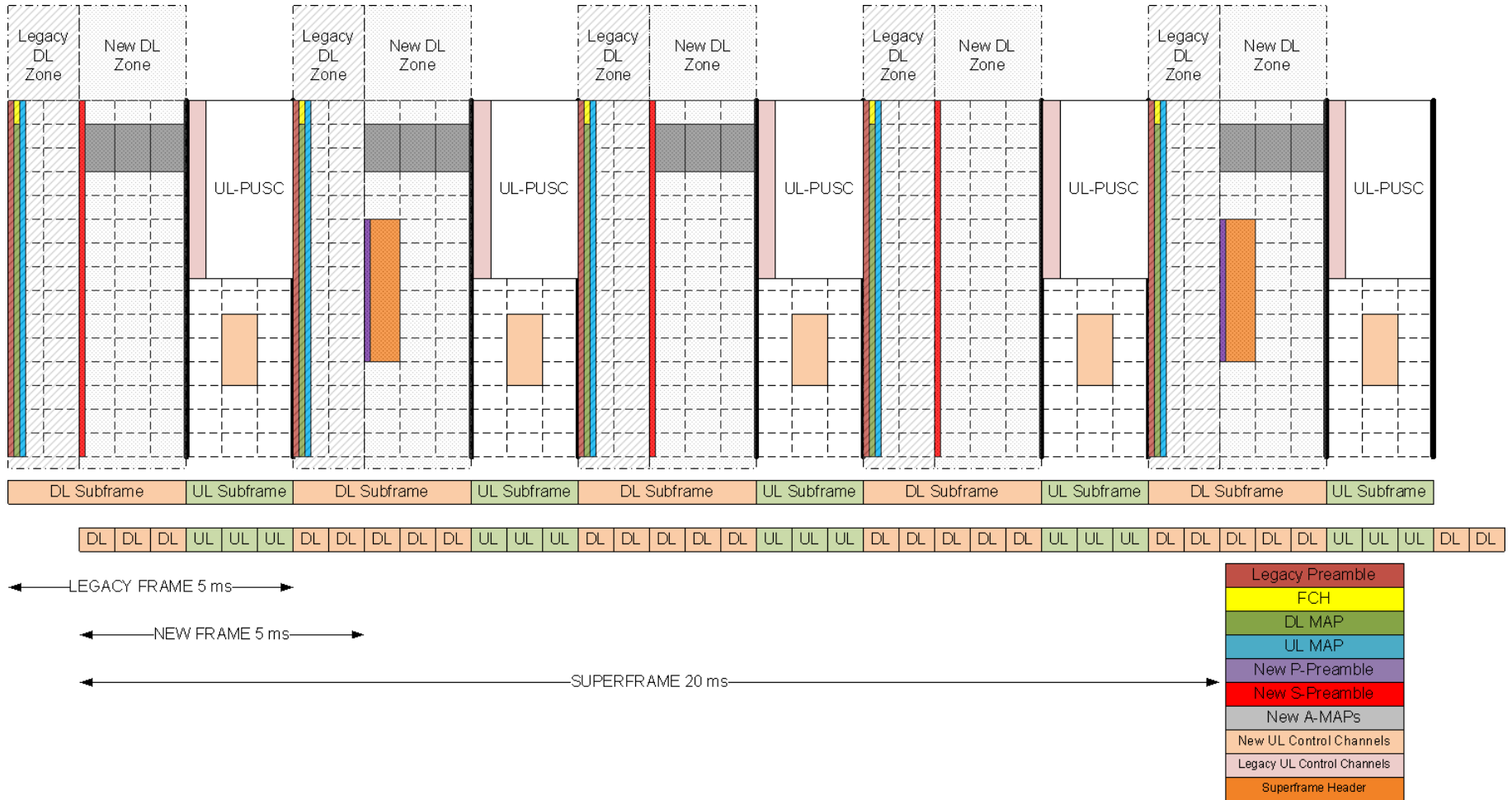

# HARQ with Legacy Support

- The association rule is same as Greenfield case.
- Calculation of processing time (whether to postpone one frame) is based on the renumbered index.

Subframe index( $l', m', n'$ ): DL= $\{0, 1, \dots, D'-1\}$ , UL= $\{0, 1, \dots, U'-1\}$

Subframe index( $l, m, n$ ): DL= $\{0, 1, \dots, D-1\}$ , UL= $\{0, 1, \dots, U-1\}$

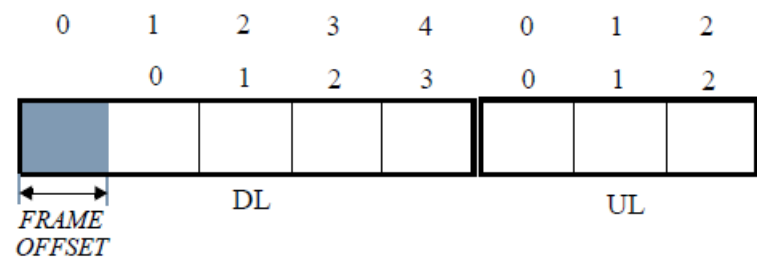

- Example

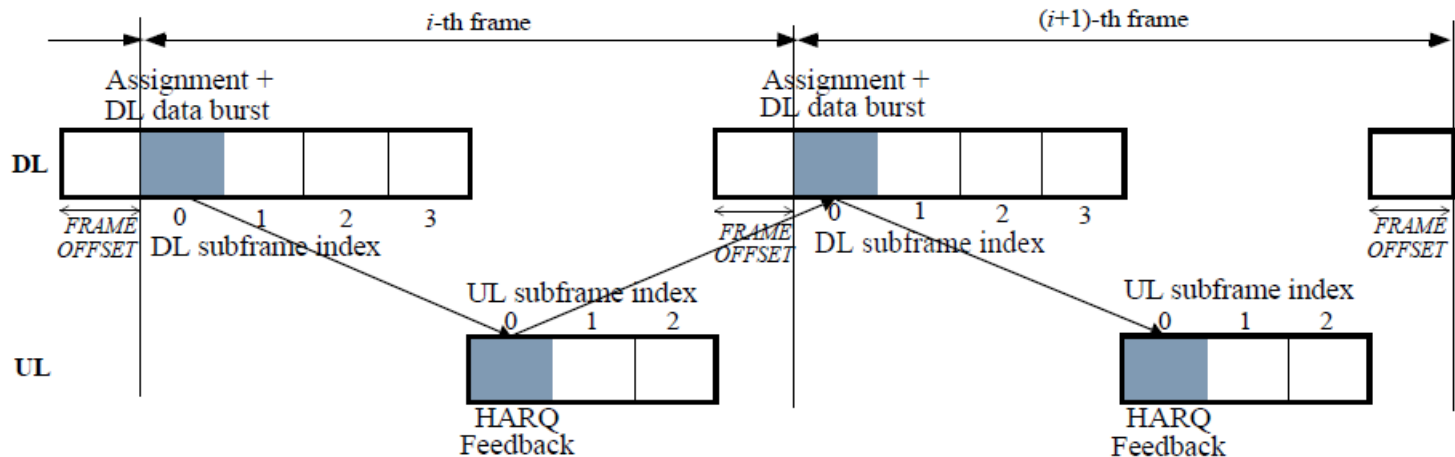

# L1/L2 Overhead in Mixed Mode Operation

Overhead Components	IEEE 802.16e		IEEE 802.16m		Mixed Mode	
	Minimum	Maximum	Minimum	Maximum	Minimum	Maximum
CP=1/8, BW=10 MHz, DL 2x2 MIMO						
L1 overhead	0.393	0.393	0.293	0.297	0.331	0.346
L1/L2 Overhead	0.446	0.568	0.337	0.424	0.404	0.512

The new system has lower L1/L2 overhead relative to the legacy system for a fully-loaded cell.

The mixed-mode operation has also lower L1/L2 overhead relative to the legacy system. New subchannelization schemes, symbol structure, control channel structure design have helped reduce the L1/L2 overhead and increase reliability of the system.

## **Advanced Features**

# Multi-Carrier Operation

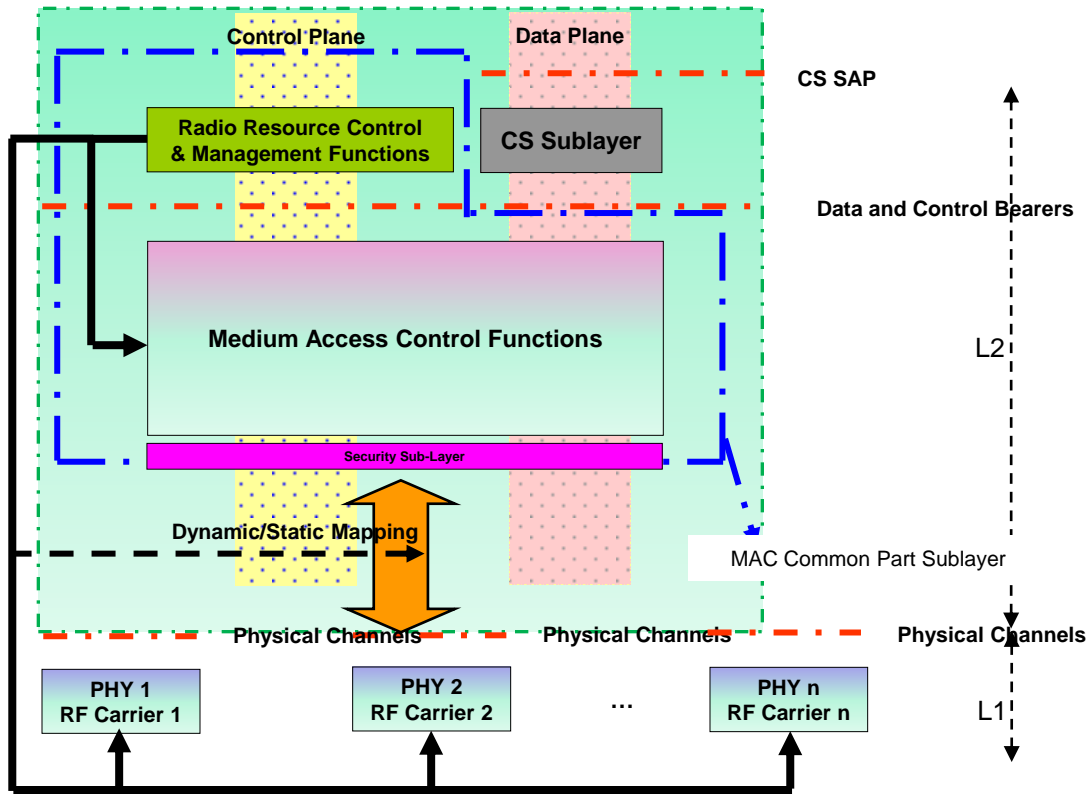

A generalized protocol architecture for support multicarrier operation with single MAC entity

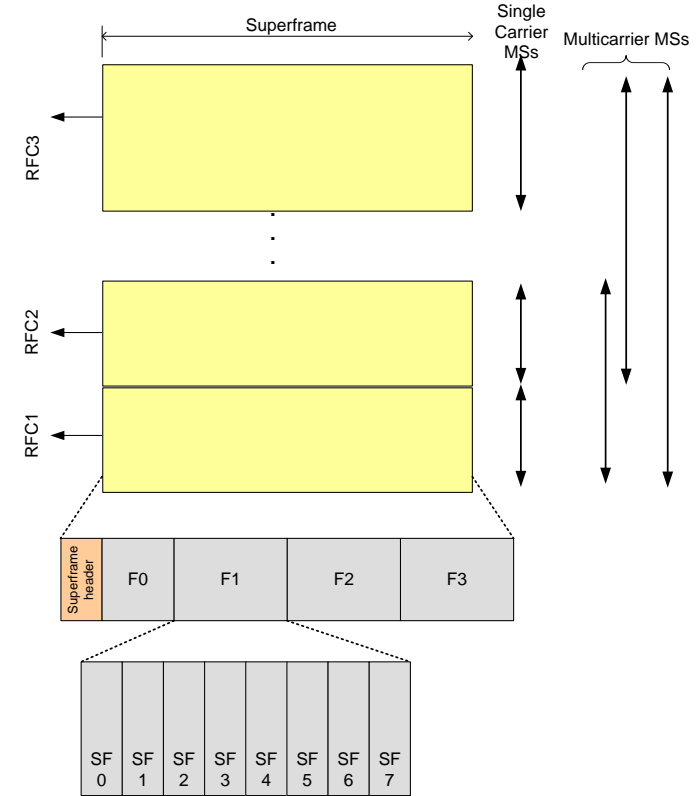

Support of multi-carrier operation in 802.16m basic frame structure

Some MAC messages sent on one carrier may also apply to other carriers. The RF carriers may be of different bandwidths and can be non-contiguous or belong to different frequency bands. The channels may be of different duplexing modes, e.g. FDD, TDD, or a mix of bidirectional and broadcast only carriers. Support of wider bandwidths (up to 100 MHz) through aggregation across contiguous or non-contiguous channels. The RF carriers can be fully or partially configured.

# Support of Femtocells and Self-Organization

Femto-cells are low power cellular base stations deployed in homes. Mobile stations can be used inside homes with the home broadband connection as backhaul. The distinction is that most femtocell architectures require a new (dual-mode) handset which works with existing home/enterprise Wi-Fi access points, while a femto-cell-based deployment will work with existing handsets but requires installation of a new access point.

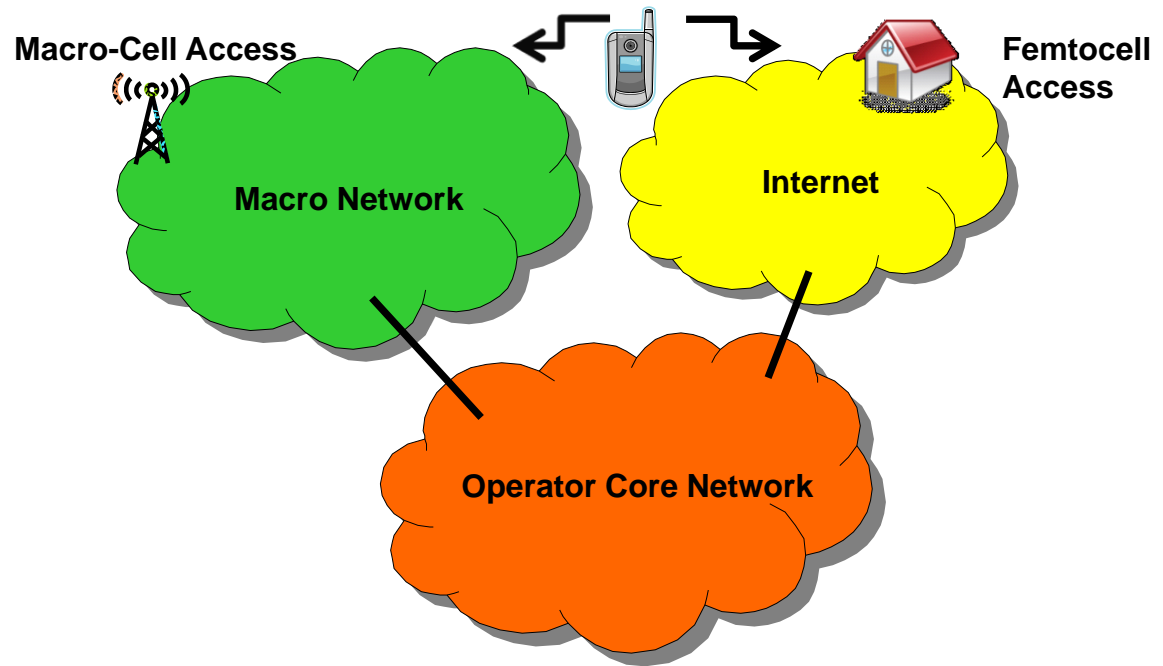

IEEE 802.16m provides

- 1) Very high data rates and service continuity in smaller cells including indoor pico cells, femto cells, and hot-spots. The small cells may be deployed as an overlay to larger outdoor cells.
- 2) Self-configuration by allowing real plug and play installation of network nodes and cells, i.e. self-adaptation of the initial configuration, including the update of neighbor nodes and neighbor cells as well as means for fast reconfiguration and compensation in failure cases.
- 3) Self-optimization by allowing automated or autonomous optimization of network performance with respect to service availability, QoS, network efficiency and throughput.

# Multi-RAT Operation and Handoff

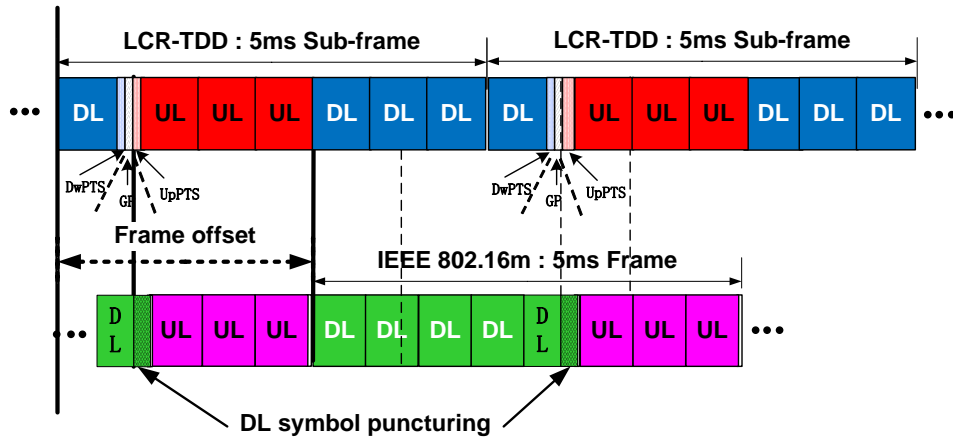

Adjacent Channel Coexistence with UTRA LCR-TDD (TD-SCDMA)

IEEE 802.16m supports interworking functionality to allow efficient handover to other radio access technologies including 802.11, GSM/EDGE, UTRA (FDD and TDD), E-UTRA (FDD and TDD), and CDMA2000

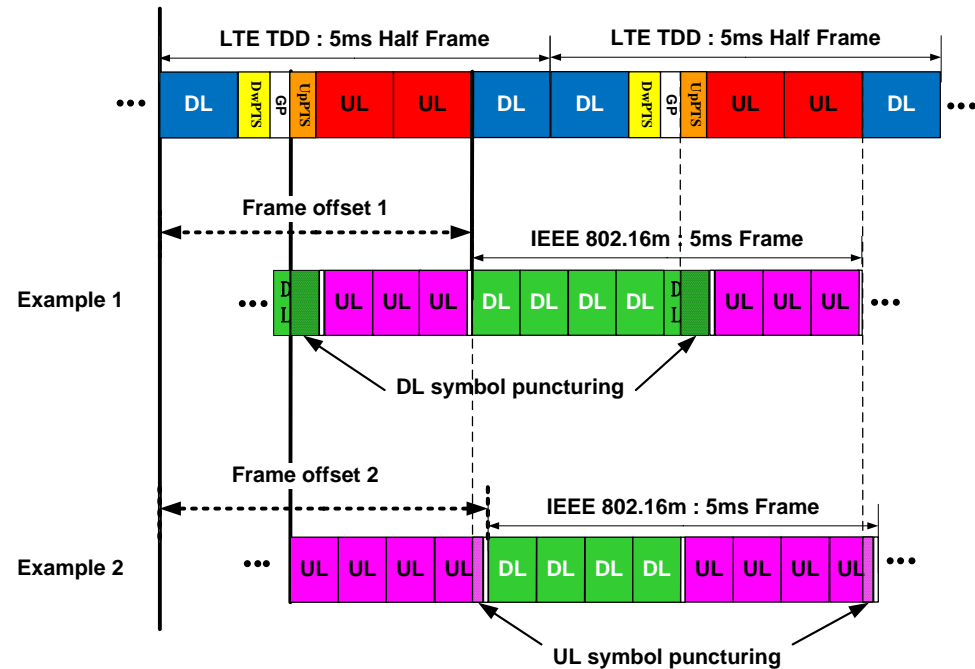

Adjacent Channel Coexistence with E-UTRA (TD-LTE)

# Multi-Radio Coexistence Support

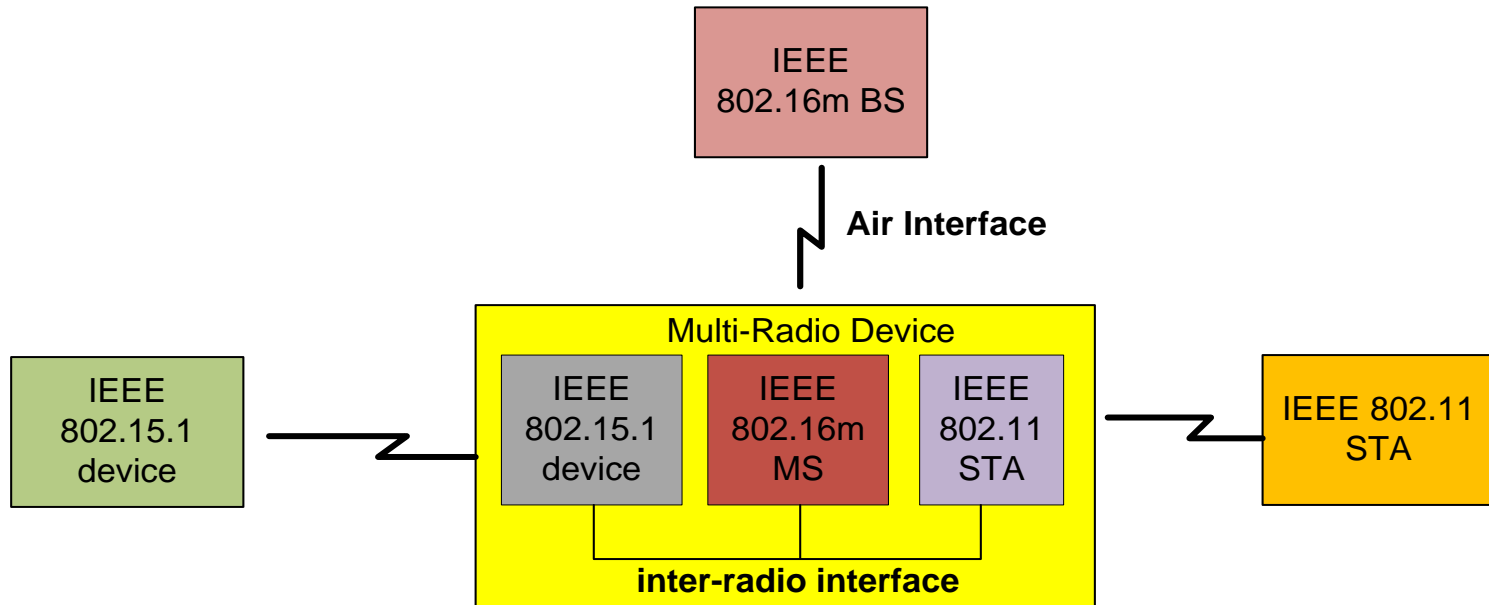

**Multi-Radio Device with Co-Located 802.16m MS, 802.11 STA, and 802.15.1 device**

IEEE 802.16m provides protocols for the multi-radio coexistence functional blocks of MS and BS to communicate with each other via air interface.

MS generates management messages to report its co-located radio activities to BS, and BS generates management messages to respond with the corresponding actions to support multi-radio coexistence operation.

The multi-radio coexistence functional block at BS communicates with the scheduler functional block to operate properly according to the reported co-located coexistence activities.

# Enhanced Multicast and Broadcast Service

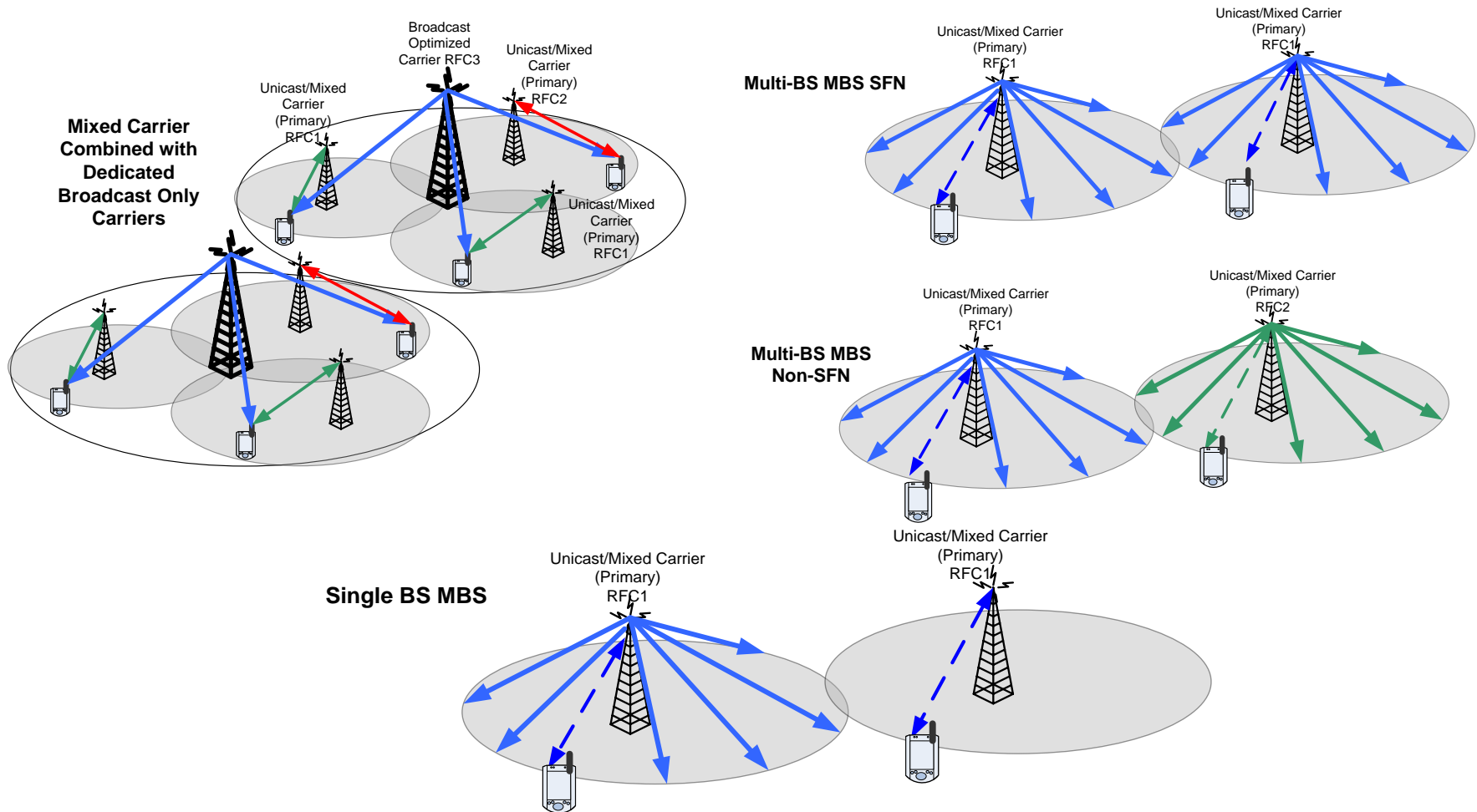

E-MBS can be multiplexed with unicast services or deployed on a dedicated carrier

# Multi-hop Relay-Enabled Architecture

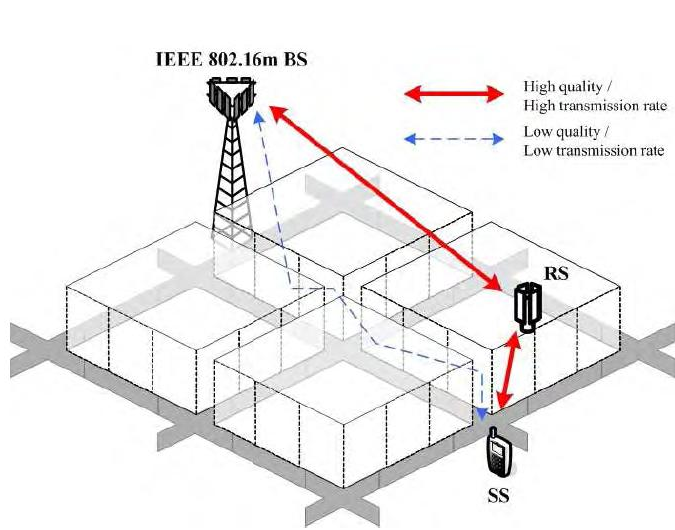

Relays can enhance transmission rate for the MS located in shaded area or cell boundary

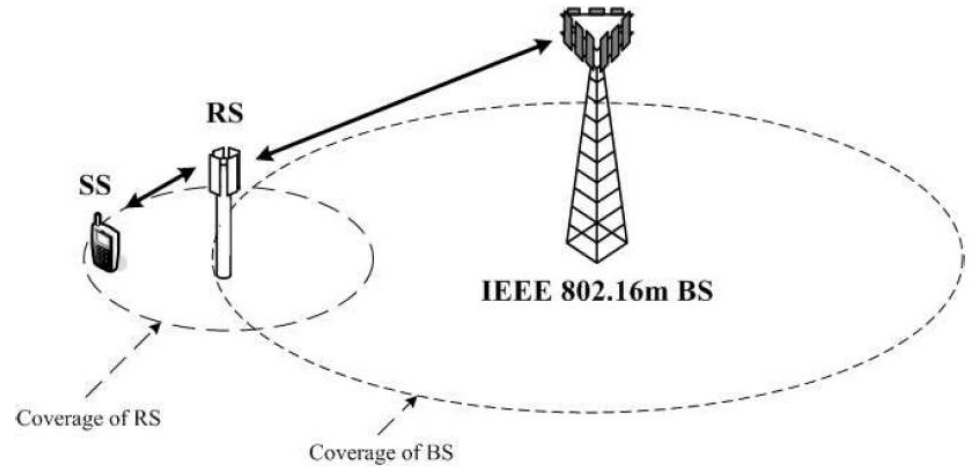

Coverage extension by deploying RS in 802.16m network

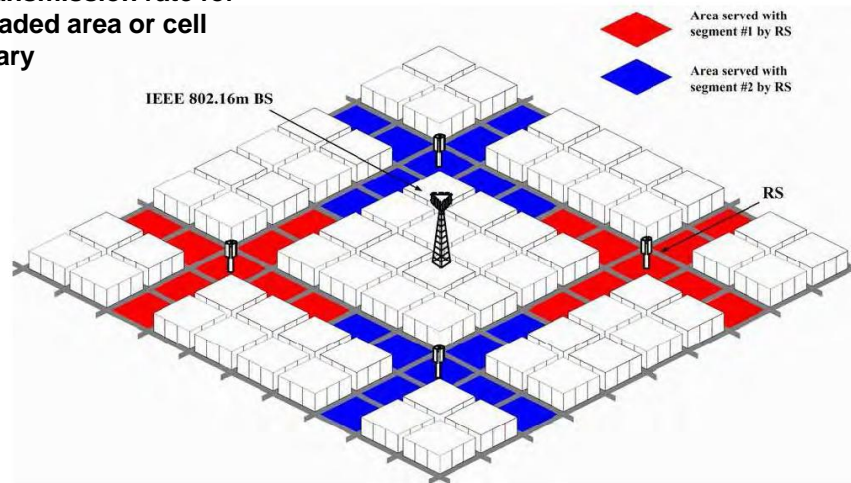

More aggressive radio resource reuse by deploying RS in 802.16m network

# References

## Core Documents

1. [P802.16m Project Authorization \(PAR\)](#)
2. [P802.16m Five Criteria](#)
3. [IEEE 802.16m Work Plan](#)
4. [IEEE 802.16m System Requirements Document \(SRD\)](#)
5. [IEEE 802.16m System Description Document \(SDD\)](#)
6. [IEEE 802.16m Evaluation Methodology Document \(EMD\)](#)
7. [IEEE 802.16m Amendment Working Document \(AWD\)](#)
8. [System Evaluation Details for IEEE 802.16 IMT-Advanced Proposal \(SED\)](#)
9. [Candidate IMT-Advanced RIT based on IEEE 802.16 \(IEEE Contribution to ITU-R Working Party 5D\)](#)
10. [Style Guide for 802.16m Amendment Contributions](#)
11. [IEEE 802.16m Internal Documents Configuration Control Procedure \(CCP\)](#)

## Additional Resources

1. IEEE 802.16 IMT-Advanced Candidate Proposal Page <http://ieee802.org/16/imt-adv/index.html>
2. [Letter Ballot #30](#)